

Soft-Switching Converter

MOHAMMAD AMIR ANSARI¹, ASHISH SINGHAL²

^{1,2}Dept. of Electrical Engineering, Sagar Institute Of science Engineering and Technology

Abstract - A new Zero-Voltage Transition based two input DC-DC converter sufficient to draw power from two distinct sources feeding a common dc-bus is presented in this paper.. The main objective here is to realize the soft-switching by integrating the ZVT cell into the two input DC-DC converter enabling to improve the efficiency by reducing the switching losses in the converter. The digital voltage-mode controller for the converter is designed using SISO tool in MATLAB. A 24V, 96W converter is analyzed and compared with the simulation results.

I. INTRODUCTION

DC-DC converter is one of the most important and widely used devices of modern power applications. Power electronics field in the last decade has been the development of switching-mode converters with higher power density and low electromagnetic interference. Light weight, small size and high power density are also some of the key design parameters. Several different types of switch-mode dc-dc converters belongs to buck, boost and buck-boost topologies, have been developed and reported in the literature to meet variety of applications [1]. Major concern in the recent dc distribution systems, such as in automotive and telecom power supply systems, is to meet the increased power demand and reducing the load on the primary energy source, i.e. built-in battery. This is possible by adding additional power sources in parallel to the existing battery source. The additional power sources can be: (i) renewable energy sources such as photovoltaic (PV) or wind, (ii) fuel cell storage power [2].

Integration of renewable energy sources to form a distributed generation system is another option for the hybrid vehicles, automotive industries and even in remote standalone power supply system. In order to efficiently and economically utilize renewable energy resources it is necessary to tap the energy as and when it is available and then store for subsequent utilization [3]-[5]. However, the power conversion efficiency and its control is major challenge for the power supply designer. The efficiency improvement with higher power density, from the steady-state point of view, of

the distributed energy generation is one of the considerations for the designer. The other difficulty is while designing such system is to evolve simple and reliable power control strategy [6]-[8]. To address some of the above issues, multi-input converters, with different topology combinations, are evolving. Although several power conversion topology configurations can easily be developed, but an integrated converter with bucking, buck-boost feature is desired in most of these schemes [9]-[10].

To this affect, there is no sufficient literature covering the development of converter and control schemes for such applications. Further, literature including design aspects of digital controllers for such kinds of converters is also limited. In order to cover this gap, a new two-input dc-dc converter is proposed in this paper and then digital controllers have been designed to ensure dc-bus voltage regulation together with power distribution control of the input dc power sources. The aim of this paper is to realize the soft-switching by integrating the ZVT cell into the two input DC-DC converter enabling to improve the efficiency by reducing the switching losses in the converter, belonging to higher order family.

II. MODELING AND ANALYSIS OF THE CONVERTER

Assuming all switching devices, energy storage elements are considered to be ideal. The voltage source in series with input inductors (L_1) and (L_2) is considered to be an ideal current source (I_{g1}) and (I_{g2}). At Output side the presence of large Capacitor (C_3) in parallel with the load has been replaced with a constant voltage source with the magnitude of V_0 .

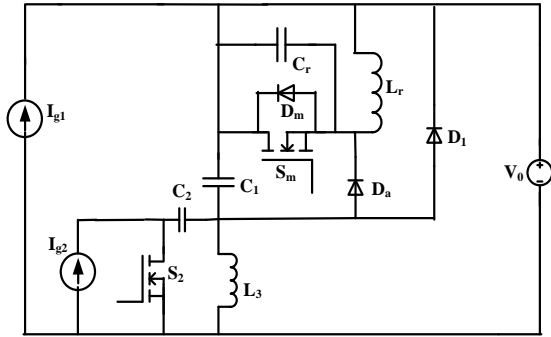

Fig.1. Two Input ZVT DC-DC Converter

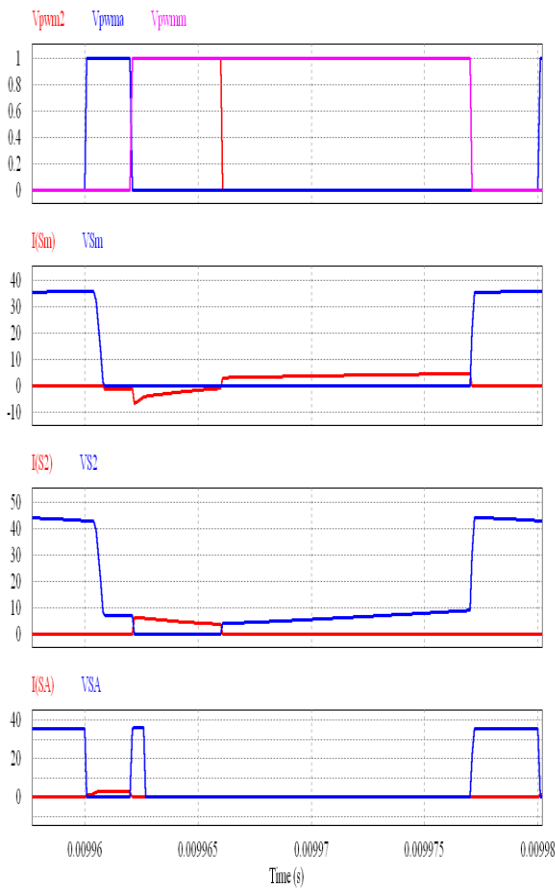

Fig.2. PWM gating signals and ZVT operating conditions of switches

III. DESIGN OF DIGITAL CONTROLLER

Although the conventional DC-DC converter is capable of stepping-up of voltages, but the load side requires a huge capacitance to filter-out the switching frequency harmonics. However, use of larger capacitance lead to higher starting inrush current and

sometimes this may be more than the overload capacity of the given converter and hence single stage filter may not be recommended for the reasons mentioned above. Adding LC low-pass filter on the output stage is one of the feasible solutions. However, addition of LC-filter on load increases the system order and hence its controller design is an important aspect to the power supply designer.

Digital control of the power supply systems is coming-up in recent days due to the advancement of the technology in the area of micro-controller and digital signal processors. In general, the digital control offers several advantages, over the analog control, but few of them are as follows: (i) less susceptible to ageing and environment variations, (ii) less sensitive to noise, (iii) provide improved sensitivity to parameter variations, etc. There are several different ways to realize the digital controllers for the power supplies. However, there are two different control schemes, widely used in the power supply industries, which are: (i) voltage-mode control, (ii) current-mode control. Among these two control strategies, the voltage-mode scheme is quite attractive and efficient. Further, there are no unstable issues, arising due to adding current-loop, and dynamic response time is almost close to the cascade control. Hence, in this paper a digital voltage-mode controller is employed for the zero-voltage transition two input DC-DC converter.

IV. SIMULATION RESULTS

The simulation is carried out with the aim to study the voltage and current waveforms of the circuit components. The voltage and current waveforms of all the switching devices are recorded in order to obtain their switching performance. The main, second and auxiliary switches undergo soft transition during turn-on whereas the power circuit diode and the auxiliary diode undergo soft transitions during turn-off as per the mode analysis done.

The PWM gate signals for main, second and auxiliary switches used in the simulation process are shown in Fig.2. Here, the rising edge of the main switch gate signal and rising edge of the second switch gate signal should be synchronized each other. The voltage-mode controller transfer functions that are

designed considering the above stability limits are shown below.

Transfer function 1:

$$G_{p1}(z) = \frac{\hat{v}_o(z)}{\hat{d}_m(z)} = \frac{0.1587z^5 + 0.2319z^4 + 0.07699z^3 - 0.08286z^2 - 0.2172z - 0.131}{z^6 + 0.5487z^5 - 0.7552z^4 - 0.9493z^3 - 0.8815z^2 + 0.3993z + 0.6434}$$

Transfer function 2:

$$G_{p2}(z) = \frac{\hat{v}_o(z)}{\hat{d}_2(z)} = \frac{0.06718z^5 - 0.0851z^4 - 0.04213z^3 + 0.07552z^2 - 0.01212z - 0.002325}{z^6 - 2.224z^5 + 0.903z^4 + 1.378z^3 - 1.545z^2 + 0.5217z - 0.02966}$$

Compensator transfer function 1:

$$G_{c1}(z) = \frac{0.3094(z - 0.833)(z - 0.87)}{(z - 1)(z - 0.944)} \quad (8)$$

Compensator transfer function 2:

$$G_{c2}(z) = \frac{0.66(z - 0.841)(z - 0.956)}{(z - 1)(z - 0.997)} \quad (9)$$

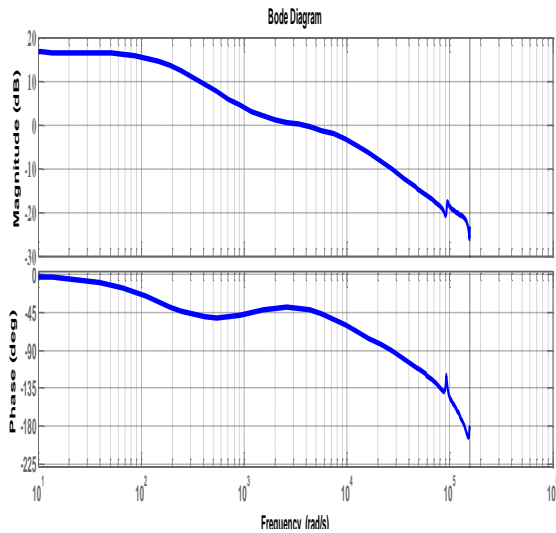

Fig.4. Frequency response characteristics of the converter transfer function $G_{p1}(z)$.

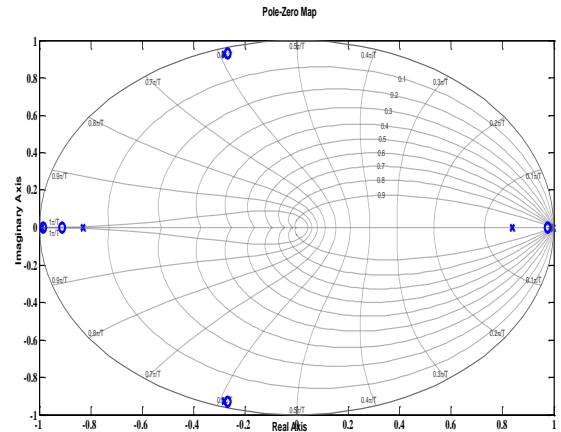

Fig.5. Pole-zero plot of the converter transfer function $G_{p1}(z)$.

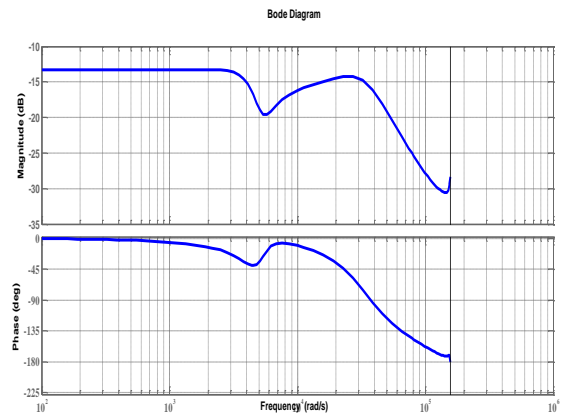

Fig.6. Frequency response characteristics of the converter transfer function $G_{p2}(z)$.

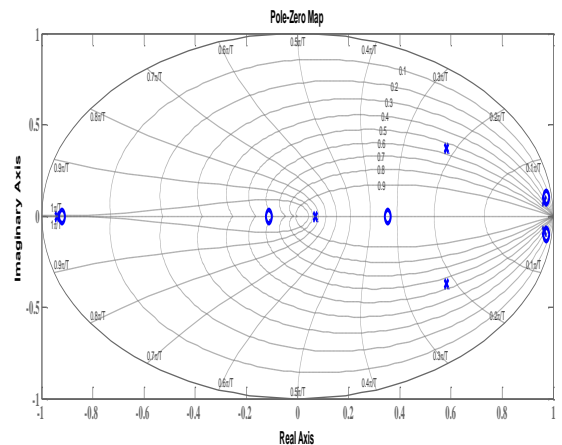

Fig.7. Pole-zero plot of the converter transfer function $G_{p2}(z)$.

The effectiveness of the designed controller has been verified in simulation for load side and source side disturbances. A load disturbance of load resistance from 150 to 70 Ω has been created after 15ms and the controller action made the converter to regulate the voltage and found the controller action to be satisfactory which made the transients to die down. The corresponding results shown in Fig.8. A sudden source disturbance of 36 to 40V for first source and 12 to 16V for second source has been created in the source voltages after 15 ms and the controller action made the converter to regulate the voltage and also found the controller action to be satisfactory which made the transients to die down.

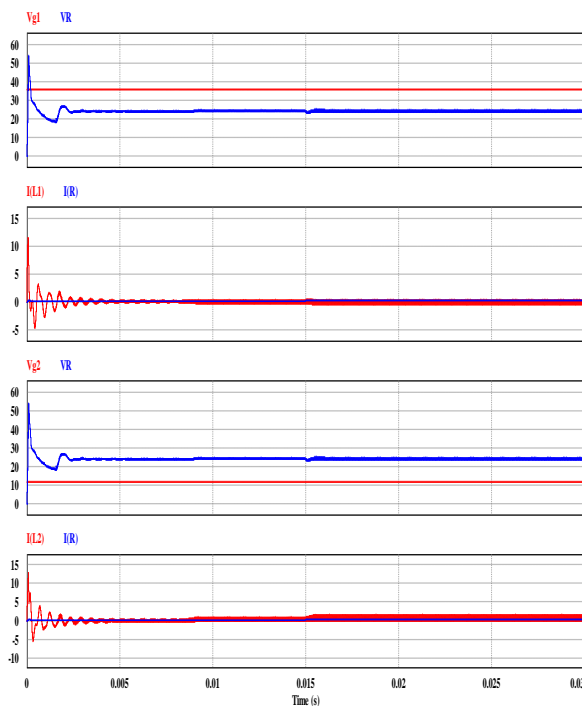

Fig.8. Dynamic response characteristics of the converter ($R= 150 \rightarrow 70\Omega$).

V. CONCLUSION

In this paper a two input DC-DC converter using an auxiliary resonant circuit is proposed which offered significant advantages over conventional converters. This higher order converter provides higher voltage level at lower duty ratios and the ripple at input and output is also reduced. The zero-voltage transition cell was also incorporated into the circuit providing further advantages in terms of reduction of switching losses

for nearly all the switching devices. The ZVT operation of the main switch and the soft-switching for all other switching devices was achieved in the simulation when employed with the proper gating sequence for the main, second and auxiliary switches. The selection of the resonant tank elements is playing a very important role in achieving soft-switching operation for switches. It is seen that the main switch and the auxiliary switch operate for the soft-switching. The converter control-to-output voltage transfer functions are obtained and its frequency response characteristics were analyzed. The digital voltage-mode controller for the converter has been designed using MATLAB. The GM and PM of the designed controller are within stability limits.

VI. REFERENCES

- [1] K.H. Liu, F.C. Lee, "Zero-voltage switching technique in dc-dc converters," IEEE Power Electronics Specialists Conf Rec., 1986, pp. 293-304.
- [2] W.A. Tabisz, P. Gradzki, F.C. Lee, "Zero voltage-switched quasi-resonant buck and flyback converter - Experimental results at 10MHz," IEEE Trans. on Power Electronics, vol.4, no. 2, 1989, pp. 194-204.
- [3] W.A. Tabisz, F.C. Lee, "Zero-voltage-switching multi-resonant technique - A novel approach to improve performance of high-frequency quasi resonant converters," IEEE Power Electronics Specialists Conf Rec., 1988, pp. 9-17.
- [4] F.C. Lee, W.A. Tabisz, M.M. Jovanovic, "High frequency off-line power conversion using zero-voltage-switching quasi resonant and multi-resonant techniques," 3rd European Conference on Power Electronics and Applications, 1989, pp.401-410.
- [5] M.M. Jovanovic, W.A. Tabisz, F.C. Lee, "Zero-voltage-switching technique in high frequency off-line converters," IEEE Applied Power Electronics Conf Proc., 1988, pp.23- 32.
- [6] V. Vorperian, "Quasi-square wave converters: Topologies and analysis," IEEE Trans. On Power Electronics, vol. 3, no. 2, 1988, pp. 183-191.

- [7] C.P. Henze, H.C. Martin, D.W. Parsley, "Zero voltage-switching in high frequency power converters using pulse width modulation," IEEE Applied Power Electronics Conf Proc., 1988, pp. 33-40.
- [8] G. Hua, F.C. Lee, "Novel zero-current transition PWM converters," Invention Disclosure, 1991, pp. 601-606.
- [9] M. Veerachary, "Soft-Switching Fifth-Order Boost Converter", IEEE Proc. on India Conference (INDICON), 2011, pp.1-4.
- [10] M. Veerachary, "Robust stabilizing Digital Controller for Soft-Switching zero voltage turn-on H- bridge Boost Converter," IEEE Trans. Ind. Electron., vol. 58, no.7, 2011, pp.2883- 2897.
- [11] G. Hua, F.C. Lee, "A new class of zero voltage-switched PWM converters," High frequency Power Conversion Conf Proc., 1994, pp. 637-643.
- [12] G. Hua, Yiming Jiang, F.C. Lee, "Analysis, design, and experiments of ZVT-PWM boost converter," published in Virginia Power Electronic Center (WEC) Seminar, 1992, pp. 213-219.
- [13] M. Veerachary, "Two input DC-DC Converter for DC grid applications", IEEE Power India Conference , 2012, pp. 21-26.
- [14] R.W.Erickson and D.Maksimovic, "Fundamentals of Power Electronics," second edition, Springer International Edition, 2006.