

A Blind Reader Using Raspberry PI

MRUGANK PUROHIT

Poornima College Of Engineering, Jaipur, India

As indicated by the World Health association (WHO), 285 million individuals are evaluated to be outwardly hindered worldwide among which 90% live in creating nations [1]. also, forty five million visually impaired people overall [2]. In spite of the fact that there are numerous current answers for the issue of helping people who are ignorant concerning perused, however none of them give a perusing knowledge that in any capacity parallels that of the located populace. Specifically, there is a requirement for a compact content peruser that is moderate and promptly accessible to the visually impaired group. Consideration of the exceptionally empowered in the IT unrest is both a social commitment and additionally a computational test in the quickly progressing computerized world today. This work proposes a keen peruser for outwardly tested individuals utilizing raspberry pi. This paper tends to the coordination of a total Text Read-out framework intended for the outwardly tested. The framework comprises of a webcam interfaced with raspberry pi which acknowledges a page of printed content. The OCR (Optical Character Recognition) bundle introduced in raspberry pi examines it into a computerized record which is then subjected to skew rectification, division, before include extraction to perform grouping. When ordered, the content is readout by a content to discourse change unit (TTS motor) introduced in raspberry pi. The yield is sustained to a sound enhancer before it is perused out. The reproduction for the proposed undertaking should be possible in MATLAB. The reproduction is only a start of picture handling ie., the picture to content change and content to discourse transformation done by the OCR programming introduced in raspberry pi. The framework finds intriguing applications in libraries, theaters, workplaces where guidelines and notification are to be perused and furthermore in helped filling of use shapes. Results alongside examination are displayed.

Indexed Terms: Raspberry pi, Web Cam, Optical character recognition, Text to Speech Engine, Audio amplifier.

I. INTRODUCTION

Outwardly hindered individuals report various troubles with getting to printed content utilizing existing innovation, incorporating issues with arrangement, center, precision, portability and

effectiveness. We exhibit a keen gadget that helps the outwardly debilitated which adequately and effectively peruses paper-printed content. The proposed venture utilizes the technique of a camera based assistive gadget that can be utilized by individuals to peruse Text archive. The structure is on actualizing picture catching method in an implanted framework in light of Raspberry Pi board. The outline is inspired by preparatory examinations with outwardly weakened individuals, and it is little scale and portable, which empowers a more sensible task with little setup. In this undertaking we have proposed a content read out framework for the outwardly tested. The proposed completely coordinated framework has a camera as an information gadget to nourish the printed content report for digitization and the examined archive is handled by a product module the OCR (optical character acknowledgment motor) . An approach is actualized to acknowledgment grouping of characters and the line of perusing. As a major aspect of the product improvement [11] the Open CV (Open source Computer Vision) libraries is used to do picture catch of content, to do the character acknowledgment. The vast majority of the entrance innovation apparatuses worked for individuals with visual impairment and restricted vision are based on the two fundamental building pieces of OCR programming and Text-to-Speech (TTS) motors. Optical character acknowledgment (OCR) is the interpretation of caught pictures of printed content into machine-encoded content. OCR is a procedure which connects an emblematic significance with objects (letters, images a number) with the picture of a character. It is characterized as the way toward changing over checked pictures of machine printed into a PC procedure capable organization. Optical Character acknowledgment is additionally valuable for outwardly weakened individuals who can't read Text archive, however need to get to the substance of the Text reports. Optical Character acknowledgment is utilized to digitize and replicate writings that have been delivered with non-electronic framework. Digitizing writings additionally decreases storage

room. Altering and Reprinting of Text record that were imprinted on paper are tedious and work concentrated. It is broadly used to change over books and reports into electronic records for use away and archive examination. OCR makes it conceivable to apply methods, for example, machine interpretation, content to-discourse and content mining to the catch/examined page.

The last perceived content report is nourished to the yield gadgets relying upon the decision of the client. The yield gadget can be a headset associated with the raspberry pi board or a speaker which can illuminate the content archive so anyone might hear.

Pervasiveness of visual impairment (per thousand) according to the gauge of 2015

Types of blindness	Urban	Rural	Total
Total blindness	4.43	5.99	5.40
Economic blindness	11.14	15.44	13.83
One eye blindness	8.23	7.00	7.46

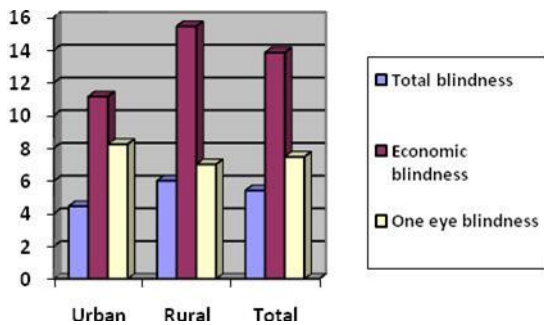

Figure.1 Survey of blind people

Add up to Blindness = Visual sharpness under 3/60 in better eye with display amendment

Financial visual impairment = Visual keenness under 6/60 in the better eye with exhibition adjustment

One eye visual impairment = Visual sharpness under 3/60 out of one eye and superior to 6/60 in the other eye with exhibition adjustment.

II. BLOCK DIAGRAM OF PRPOSESED METHOD

The figure 1 illustrates the block diagram of proposed method. The framework of the proposed project is the raspberry pi board. The raspberry pi B+ is a single board computer which has 4 USB ports, an Ethernet port for internet connection, 40 GPIO pins for input/output, CSI

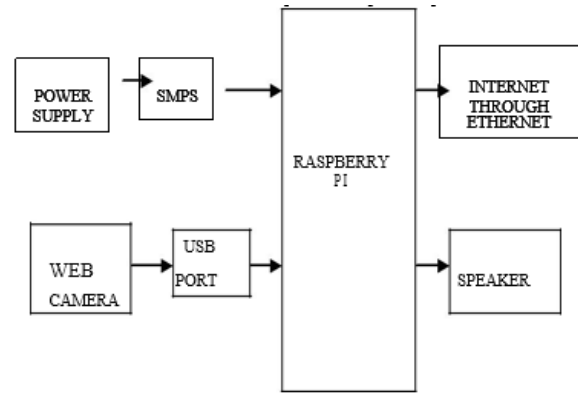

Figure.2 Block diagram of Proposed Method

Camera interface, HDMI port, DSI display interface, SOC (system on a chip), LAN controller, SD card slot, audio jack, and RCA video socket and 5V micro USB connector.

The power supply is given to the 5V miniaturized scale USB connector of raspberry pi through the Switched Mode Power Supply (SMPS). The SMPS changes over the 230V AC supply to 5V DC. The web camera is associated with the USB port of raspberry pi. The raspberry pi has an OS named RASPION which process the changes. The sound yield is taken from the sound jack of the raspberry pi. The changed over discourse yield is opened up utilizing a sound enhancer. The Internet is associated through the Ethernet port in raspberry pi. The page to be perused is set on a base and the camera is engaged to catch the picture. The caught picture is prepared by the OCR programming introduced in raspberry pi. The caught picture is changed over to content by the product. The content is changed over into discourse by the TTS motor. The last yield is given to the sound enhancer from which it is associated with the speaker. Speaker can likewise be substituted by an earphone for comfort.

III. FLOW OF PROCESS

3.1 IMAGE CAPTURING

The first step in which the device is moved over the printed page and the inbuilt camera captures the images of the text. The quality of the image captured will be high so as to have fast and clear recognition due to the high resolution camera

3.2 PRE-PROCESSING

Pre-handling stage comprises of three stages: Skew Correction, Linearization and Noise expulsion. The caught picture is checked for skewing. There are conceivable outcomes of picture getting skewed with either left or right introduction. Here the picture is first lit up and binaries.

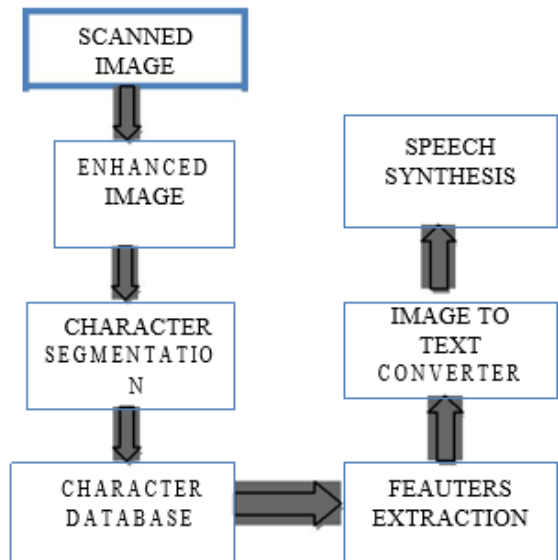

Figure. 3 Flow of process

The capacity for skew discovery checks for a point of introduction between ±15 degrees and if identified then a straightforward picture turn is done till the lines coordinate with the genuine level hub, which delivers a skew amended picture. The commotion acquainted amid catching or due with poor nature of the page must be cleared before additionally handling.

3.3 SEGMENTATION

After pre-preparing, the clamor free picture is passed to the segmentation stage. It is an activity that looks to

deteriorate a picture of succession o characters into sub-picture of individual image (characters). The binarized picture is checked for entomb line spaces. On the off chance that entomb line spaces are distinguished then the picture is divided into sets of sections over the interline hole. The lines in the sections are examined for level space crossing point as for the foundation. Histogram of the picture is utilized to recognize the width of the even lines. At that point the lines are filtered vertically for vertical space convergence. Here histograms are utilized to recognize the width of the words. At that point the words are deteriorated into characters utilizing character width calculation

3.4 FEATURE EXTRACTION

Highlight extraction is the individual picture glyph is considered and separated for highlights. Initial a character glyph is characterized by the accompanying qualities:

- (1) Height of the character;
- (2) Width of the character;
- (3) Numbers of even lines show—short and long;
- (4) Numbers of vertical lines introduce—short and long;
- (5) Numbers of circles introduce;
- (6) Numbers of on a level plane situated circular segments;
- (7) Numbers of vertically arranged bends;
- (8) Centroid of the picture;
- (9) Position of the different highlights;
- (10) Pixels in the different areas.

3.5 IMAGE TO TEXT CONVERTER

The ASCII estimations of the perceived characters are prepared by Raspberry Pi board. Here every one of the characters is coordinated with its relating format and

spared as standardized content translation. This translation is additionally conveyed to sound yield.

3.6 TEXT TO SPEECH

The extent of this module is started with the finish of the subsiding module of Character Recognition. The module plays out the assignment of change of the changed Tamil content to capable of being heard shape.

The Raspberry Pi has an on-board sound jack, the on-board sound is produced by a PWM yield and is negligibly separated. A USB sound card can significantly enhance the sound quality and volume.

Two choices of connecting a mouthpiece into Raspberry Pi. One is to have USB mic, another to have an outside USB sound card.

IV. SIMULATION ENVIRONMENT

The picture to content and content to discourse change is finished by the OCR programming introduced in raspberry pi. The change which is done in OCR can be mimicked in MATLAB. The transformation process in MATLAB incorporates the accompanying procedures.

1. Parallel picture change.
2. Complementation.
3. Division and naming.
4. Disengaging the skeleton of character.

4.1 SAMPLE IMAGE

The accompanying picture which is caught by the webcam contains the accompanying word. This picture is in the jpeg organize which must be changed over into content.



Figure. 4 Sample Image

4.2 BINARY CONVERSION

In this area test picture is changed over into parallel organization. The picture which was a 3D picture at first is changed over to 2D picture. Binary 0 speaks to dark shade of the characters. Paired 1 speaks to white shade of the characters.



Figure. 5 Binary 0 text representation

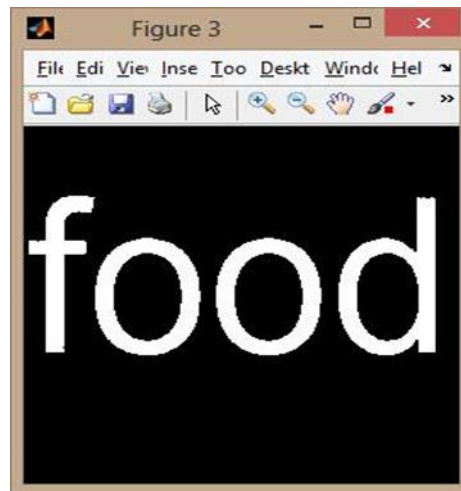

Figure .6 Binary 1 text representation

4.3 BOUNDARY MARKING

The zone of the content is circumscribed and the limit for each character is detached. The limit for each character is customized and it can fluctuate from 0 to 255 bits of characters involving memory in the database.

4.4 Segmentation and labelling

The confined squares of characters are divided and are consequently named for personality. Picture division is the way toward apportioning an advanced picture into numerous sections (sets of pixels, otherwise called super pixels).

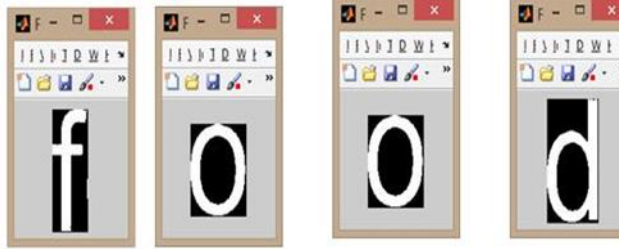

Figure 7 Segmentation and labelling

The after effect of picture division is an arrangement of fragments that on the whole cover the whole picture, or an arrangement of forms extricated from the picture (see edge discovery). Every one of the pixels in a locale are comparative concerning some trademark or processed property, for example, shading, force, or surface. Contiguous districts are fundamentally extraordinary regarding similar attributes.

Associated part marking is utilized as a part of PC vision to identify associated areas in twofold computerized pictures, despite the fact that shading pictures and information with higher dimensionality can likewise be prepared. At the point when coordinated into a picture acknowledgment framework or human-PC communication interface, associated part marking can work on an assortment of data. Blob extraction is for the most part performed on the subsequent double picture from a thresholding step. Blobs might be checked, separated, and followed.

4.5 FORMING CHARACTER SKELETON

Skeletonization is a procedure for decreasing closer view locales in a parallel picture to a skeletal leftover that to a great extent safeguards the degree and network of the first area while discarding a large portion of the first frontal area pixels. To perceive how this functions, envision that the frontal area locales in the info twofold picture are made of some uniform moderate consuming material.

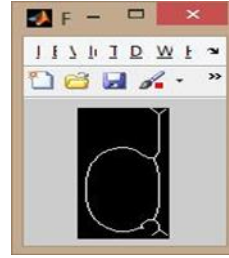

Figure 7.1 Character Skeleton

Light flames at the same time at all focuses along the limit of this district and watch the fire move into the inside. At focuses where the fire going from two unique limits meets itself, the fire will douse itself and the focuses at which this happens frame the supposed 'quench line'

4.6 AUDIO OUTPUT

The programming codes are keep running in MATLAB and comparing yield is produced. The yield is as sound. The sound is heard utilizing earphone or speaker associated with the framework. Each character of the word is illuminated first and after that the whole word is perused out.

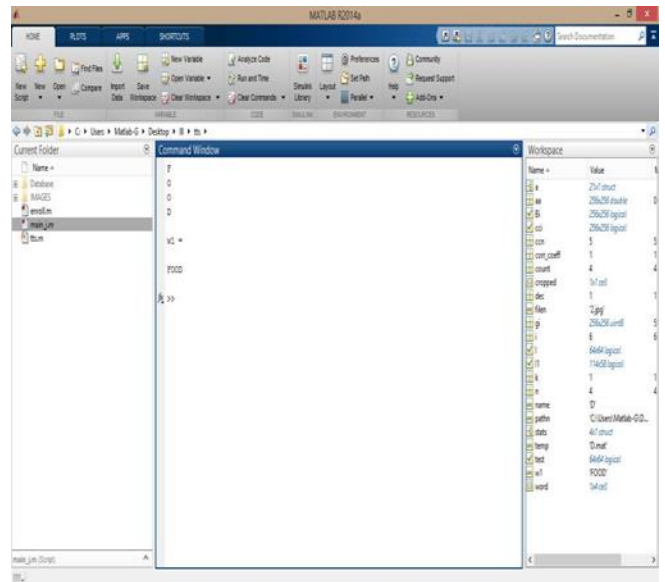

Figure 8 Audio Output

V. HARDWARE IMPLEMENTATION

The equipment of the proposed work comprises of a raspberry pi board interfaced with a USB camera. Wi Fi dongle is associated with the framework for web association which is taken to Pi through LAN link. A 5mp camera is associated with one of the USB port of raspberry pi. A 5V supply is given to Raspberry pi



Figure 9 Hardware Setup

VI. EXPERIMENTAL OUTPUTS

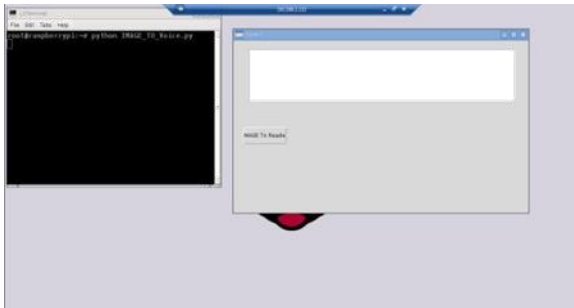

Figure 10(a) Terminal and form window

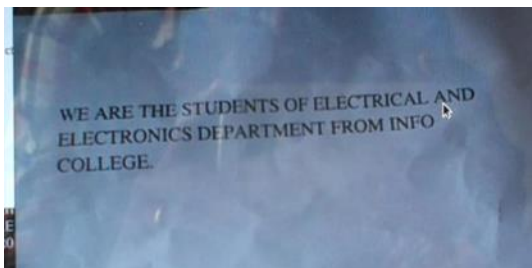

Figure 10 (b) image capturing

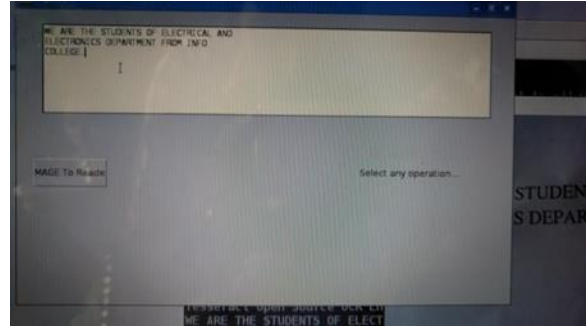

Figure 10(C) Text conversion

The content archive which must be perused out must be put at a significant separation from the webcam so the picture is sufficiently clear with appropriate brightening. The figure. 10(b) demonstrates a terminal window which is seen on the double we change on to raspion OS. In the terminal window the charge for picture to content change must be given. Quickly a frame window opens. In the frame window, an exchange box is seen named 'picture to peruse'. That alternative must be clicked to empower the webcam. The webcam auto centers the picture and it is caught.

The figure.10 (a) demonstrates an example picture which has been caught utilizing the webcam. The picture which has been prepared is shown in the frame window. This is appeared in figure.10(c). The showed picture is perused out by the content to discourse motor ESPEAK.

VII. CONCLUSION

We have executed a picture to discourse transformation system utilizing raspberry pi. The reproduction comes about have been effectively checked and the equipment yield has been tried utilizing distinctive examples. Our calculation effectively forms the picture and understands it out plainly. This is a prudent and additionally effective gadget for the outwardly debilitated individuals. We have connected our calculation on numerous pictures and found that it effectively does its change. The gadget is minimized and accommodating to the general public.

REFERENCES

- [1] Bindu Philip and r. d. sudhaker Samuel 2009 “Human machine interface – a smart ocr for the visually challenged” International journal of recent trends in engineering, vol no.3,November
- [2] Roy shilkrot, pattie maes, jochen huber, suranga c. nanayakkara, connie k (april may 2014) “Finger reader: a wearable device to support text reading on the go”Journal of emerging trend and information
- [3] Prachi khilari, bhope v. (july 2015) “Online speech to text engine” International journal of innovative research in science, engineering and technology. vol. 4, issue 7, july 2015
- [4] Gopinath , aravind , pooja et.Al “Text to speech conversion using matlab” International journal of emerging technology and advanced engineering. volume 5, issue 1, (january 2015)
- [5] Vikram shirol, abhijit m, savitri a et al. “DRASHTI-an android reading aid” International journal of computer science and information technologies vol.6 (july 2015)
- [6] Catherine a. todd, ammara rounaq et al “An audio haptic tool for visually impaired web users” Journal of emerging trends in computing and information science vol. 3, no. 8, aug 2012.
- [7] Hay mar htun, Theingi zin, hla myo tun “Text to speech conversion using different speech synthesis” International journal of scientific & technology research volume 4, issue 07, july 2015.