

# Energy Management in Microgrid using Modified Gravitational Search Algorithm

SANDHIYA D<sup>1</sup>, CHITRA S<sup>2</sup>

<sup>1</sup>P.G Scholar, Dept of EEE., Govt. College of Technology, Coimbatore

<sup>2</sup>Asst. Professor, Dept of EEE, Govt. College of Technology, Coimbatore

*Abstract -- A microgrid is a power distribution system which can be operated with or without the main grid. An energy management strategy is required in a microgrid to regulate power flows in order to meet certain operational objectives by adjusting the power imported/exported from/to the main grid, the dispatchable Distributed Energy Resources (DER) and the controllable loads. Most of the offline approaches assume perfect forecasting which is difficult to achieve in practice. Hence an online energy management with uncertainties of renewable resources has been modelled based on Lyapunov optimization. But this method considered only demand constraints. In the proposed work an online energy management for real time management of microgrid is considered for the power flow and system operational constraints on a distribution network. This has been formulated as stochastic optimal power flow problem which is solved using Modified Gravitational Search Algorithm. Simulation results showed that this algorithm improved the power transfer capability. It also minimized the long-term operational costs when compared to the existing techniques.*

*Index Terms — Energy management, Forecasting, Gravitational Search Algorithm*

## I. INTRODUCTION

In microgrid, an energy management system is essential for optimal use of these DER in intelligent, secure, reliable, and coordinated ways. An Energy Management Strategy (EMS) is needed in a microgrid to manage power flows in order to satisfy certain operational objectives (e.g., minimizing costs). Microgrids perform dynamic management over energy sources and enables automatic self-healing operations. During peak usage, or at times of the grid failure, a microgrid can operate separately without affecting the larger grid's integrity. Microgrids interoperate with existing power systems, data systems and network infrastructure and helps in feeding power back to the larger grid

during grid failure or power outages. Renewable energy resources are presently being deployed on a large scale to meet the requirements of increased energy demand. The integration of such distributed energy sources into utility grid gives the way for microgrids.

The microgrid system consisting of distributed energy resources can operate in an islanded mode during grid failures. In microgrid, an energy management system is required for optimal use of these distributed energy resources in secure and reliable ways. To manage the volatility and intermittency of renewable energy resources, various uncertainty quantification methods are proposed. Energy management in microgrids is commonly developed as an offline optimization problem for day-ahead planning. These offline approaches assume excellent forecasting which is difficult to achieve in practice. Existing online algorithms oversimplify the microgrid model by considering the aggregate supply-demand balance. As it omits the underlying power distribution network and the associated power flow and system operational constraints. Hence for real-time operation of microgrids that takes into consideration the power flow and system operational constraints on a distribution network, an online energy management strategy (EMS) is taken. Hence its an important to replicate to a real-microgrid system.

## II. STATE OF THE ART OF ENERGY FORECASTING

In deregulated electricity market for real time operation of power system and taking part into bidding in power exchange the prediction of Market Clearing Price (MCP) or electricity price and Market Clearing Volume (MCV) or electricity load is required. Figure 1 shows the online bulletin board inside the power exchange and there is block bidding

scenarios for both demand & supply side and an equilibrium point is reached where market is clear; the price at equilibrium point is called MCP and volume at that intersection point is called MCV. However, at the time of congestion, the zonal market clearing price (ZMCP) or the Locational Marginal Price (LMP) comes into play. ZMCP is always same for a zone but it may differ from zone to zone. It may also be different for different buses. [2]

The main objective of electricity market is to maximize profit to both suppliers & consumers with high reliability of supply. Like MCV, the MCP series has also special characteristics like non-linearity and non-stationarity, high volatility, calendar, seasonal effects and its correlation with MCV. The main difference between load and price is that price series is more volatile and suffers from large price excursions; whereas, load series is periodic. Similar to load series, the modeling of price series can be done in consecutive time-series framework or variable segmented framework. In deregulated electricity market for real time operation of power system and taking part into bidding in power exchange, the prediction of MCP and MCV is required. The MCP and MCV are highly correlated with each other as the demand is increasing with respect of its price.

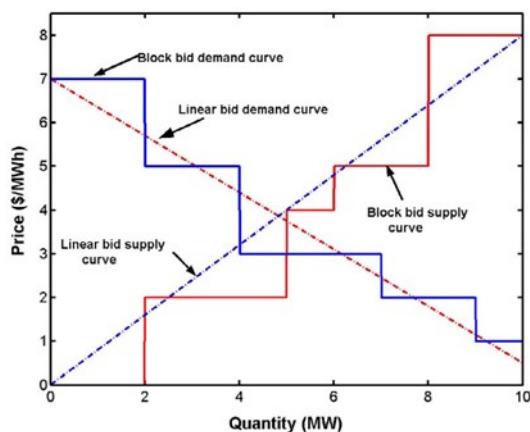

Figure 1: Online Bulletin Board Power Exchange

By the available literature, it has been observed that each model has its own characteristics and operate in different situations. However, it is quite complicated and difficult to design a perfect prediction model

with taken care of high uncertainty of load. Hence to tackle this problem, efforts have been made to capture uncertainties in forecasting energy integrated with renewable sources through modelling different scenarios. In this project work the forecasting of online EMS for micro grids integrated with renewable energy is considered by formulating optimal power flow with system operational constraints such as active power and voltage stability of the bus system.

### III. PROPOSED MODIFIED GRAVITATIONAL SEARCH ALGORITHM

To solve various optimization problems, this algorithm shows a high performance and it uses fitness performance as objective function. In GSA context, each mass (particle or agent) is represented by four specifications: the solution to the problem is represented from the *position* of the mass and the fitness function of the agent is represented by the *inertial mass, active and passive gravitational mass*. Here each mass is attracted by the neighborhood particles which have the highest mass.[11]

The performance of this algorithm is dependent on the trade-off between the exploration and exploitation abilities. The global variant of GSA has the exploitation property which means; faster convergence, since all the mass are attracted by the same best agent. The local variant of GSA has a better exploration property which means the information of the agent which acquires best position is communicated to the neighborhood agents. Hence it prevents the group of particles to get trap in local minima because the attraction to specific agent becomes weak. Therefore, the selection of size of the neighborhood agents is based on the user. The proposed Modified Gravitational Search Algorithm (MGSA) optimization technique combines both the exploitation and exploration properties of both the global and local variants of GSA. The flowchart of MGSA is given in figure 2.

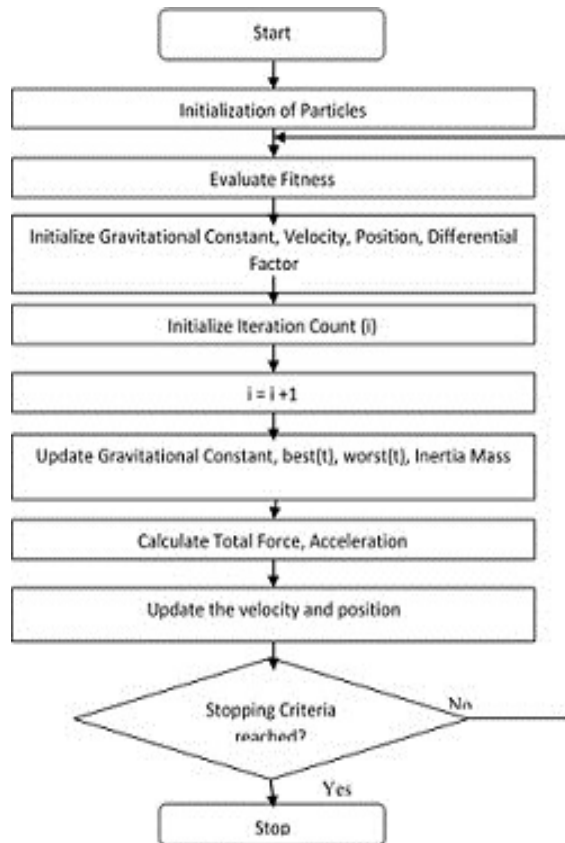

Figure 2: Flowchart of MGSA

For the simulation of MGSA, the chosen termination criterion includes the saturation value of the computed power losses over the period of iterations. On achieving the saturated values over a period of iterations, the algorithm stops else if saturation value is not reached, then the given number of iterations will be the stopping condition for the proposed MGSA simulation. It is noted that, a smooth and relatively slow transition from exploration to exploitation takes place in this scheme. Hence the MGSA variants combine the exploration and exploitation properties of both global and local GSA variants.

The modified version of GSA, which is the proposed MGSA constitutes increasing exploitation ability, and exhibits robust behavior and requires less number of iterations compared to other competitive variants due to which it is the most promising scheme. Hence The proposed approach is applied to determine the optimal solution for optimal power flow (OPF) problem in a power

system and values for optimal settings of control variables of the OPF problem.

#### IV. PROPOSED MGSA TECHNIQUE FOR VOLTAGE PROFILE IMPROVEMENT AND ACTIVE POWER LOSS MINIMIZATION

The objective (fitness) function in this case is to optimize the control parameters of the power flow and EMS also to reduce the active power losses in the power system.

The objective (fitness) function is selected to dedicate the above problem in the line is given by,

$$\min[f(V, \sigma)] = \sum_{i=1}^n \sum_{j=1}^n V_i \cdot V_j Y_{ij} \cdot \cos(\theta_{ij} + \sigma_i - \sigma_j)$$

where,

$\theta_{ij}$  :Phase limits of voltage through the bus i and j

$V_i$  : Voltage magnitude at bus i

$V_j$  : Voltage magnitude at bus j

$Y_{ij}$  : Admittance of the transmission line between bus i and j

$\sigma_i$  : Voltage phase angle at bus i

$\sigma_j$  : Voltage phase angle at bus j

It is to be noted that the power losses is computed only after finding the solutions through load flow methods.

The conventional load flow (Newton Raphson) method without prediction, load flow with prediction is incorporated in the line without optimization of control parameters and load flow with prediction incorporated in the line with optimization of control parameters employing proposed DGSA are mimicked to obtain required solution. The load flows with proposed approach and assigned parameters are tested on IEEE-14 bus system. To validate the effectiveness of the proposed DGSA approach over other optimization techniques a comparative analysis is simulated. The parameters of the evolutionary optimization algorithms used for comparing is given in Table 5.1, mainly three test cases are employed in this research work. The particulars of the test cases are given as,

Case 1: Load flow analysis when system operates with 100% nominal load.

Case 2: Load flow analysis when there is sudden increase of power at bus number 9 and 10

Case 3: Load flow analysis when there is sudden decrease of power in the system i.e system operates with 75% nominal load.

Table 1 : Parameters and their values of considered evolutionary optimization Algorithms.

S. No	Implemented	Parameters	Parametric Values
1.	Genetic Algorithm	Population Size	30
		Crossover Rate	0.6
		Mutation Rate	0.02
		No.of Generations	50
2.	Novel PSO	No. of Particles	30
		No. of Iterations	50
		Inertial Weights	0.2
		$c_1 = c_2$	0.1
3.	Proposed MGSA Parameters	Number of particles	30
		Control Parameter	0.2
		No. of Agents	30
		Maximum No. of Iteration	50
		Differential Factor	0.5

The modified IEEE 14 bus test system considered for implementing the proposed technique is shown in Figure 3. The simulated results of IEEE 14-bus system for proposed conditions with different cases are tabulated in table 1.

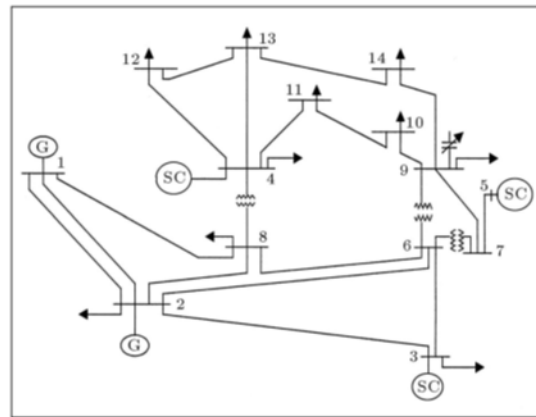

Figure 2 IEEE 14 Bus Test System

G – Generators, SC – Synchronous Compensators, Loads

A comparison between the voltage profile and active power losses at each bus are tabulated to prove the effectiveness of the proposed optimization of control parameters using developed MGSA for different test cases.

## V. SIMULATION RESULTS AND DISCUSSION

### Case 1- Load Flow Analysis When System Operates With 100% Nominal Load

In this case the test system operates with its 100% nominal load, initially the load flow is obtained using conventional (Newton Raphson) method and the results are tabulated in the Table 2. A comparison of voltage profile and active power losses at each bus is observed. There is a low voltage profile at bus no.03 and bus no.06 with respect to the conventional load flow method. The voltage profile is excised by optimizing the power flow controllers at bus no.03 and bus no.06. The tabulated results are displayed in subsequent columns. Further the proposed optimization of control parameters using MGSA technique is implemented, the control parameter values EMS are

optimized and with the optimized values of parameters the controllers show an additional improvement in voltage profile at bus no.03 and bus no.06. Due to this the active power losses in the system are reduced when compared to the conventional load flow. The faster convergence is obtained in the proposed MGSA due the addition of modification. The results of the proposed MGSA are tabulated in subsequent columns of Table 2.

*Case 2- Load Flow Analysis When There Is Sudden Increase Of Power At Bus Number 9 And 10*

In this case the test system operates with a sudden increase of power at bus no.09 and bus no.10. When the load flow is tabulated using conventional method, it results in voltage limit violation at bus no.09 and bus no.10. The results are tabulated in Table 2, as the result of low voltage profile at subsequent buses increases the active power losses in the system. Thus, the low voltage profile is alleviated by incorporating optimized values of power flow controllers at bus no. 09 and bus no.10. The results indicate improved voltage profile thereby decreasing the active power losses in the system. The results are tabulated in subsequent columns of Table 2. The control parameters EMS are optimized and load flow is calculated. The results testify that the proposed DGSA outperforms so that the voltage limit violations at bus no.09 and bus no.10 are removed and thus minimizing the active power losses progressively.

*Case 3- Load Flow Analysis When There Is Sudden Decrease Of Power In The System I.E System Operates With 75% Nominal Load*

To improve the voltage profile of the system power flow controllers are established at consequent bus with low voltage profile limits. The load flow results after power flow controllers are tabulated in subsequent columns of Table 3, with the optimal values of control parameters the controllers clearly indicates improved voltage profile in system when compared to conventional method. Due to the improved voltage profile active power losses are reduced in overall system.

Table 2 Comparative simulation results of voltage profile and active power losses for IEEE 14 Bus for case 1 with different preceding methods

Bus No.	Without controllers using conventional method Tso et al (1997)		Power flow without optimization of EMS control parameters		Power flow with optimization of EMS control parameters using proposed DGSA approach	
	profile (p.u)	power losses (MW)	profile (p.u)	power losses (MW)	profile (p.u)	power losses (MW)
1	1.0600	13.59	1.0622	12.81	1.0634	11.63
2	1.0450	13.59	1.0401	12.81	1.0409	11.63
3	1.0100	13.59	1.0215	12.81	1.0297	11.63
4	1.0500	13.59	1.0589	12.81	1.0667	11.63
5	1.0800	13.59	1.0875	12.81	1.0919	11.63
6	1.0120	13.59	1.0132	12.81	1.0242	11.63
7	1.0160	13.59	1.0188	12.81	1.0198	11.63
8	1.0450	13.59	1.0499	12.81	1.0499	11.63
9	1.0300	13.59	1.0489	12.81	1.0493	11.63
10	1.0290	13.59	1.0392	12.81	1.0418	11.63
11	1.0460	13.59	1.0481	12.81	1.0498	11.63

12	1.0533	13.59	1.0552	12.81	1.0569	11.63
13	1.0466	13.59	1.0472	12.81	1.0499	11.63
14	1.0193	13.59	1.0259	12.81	1.0295	11.63

Table 3 Simulation results of voltage profile and active power losses for IEEE 14 bus system for case 2 with different preceding methods.

Bus number	Without controllers using conventional method		Power flow without optimization of EMS control parameters		Power flow with optimization of EMS control parameters using proposed DGSA approach	
	profile	(p.u) power losses	profile	(p.u) power losses	profile (p.u)	power losses (MW)
1	1.0705	10.56	1.0707	8.45	1.0715	7.29
2	1.0450	10.56	1.0451	8.45	1.0456	7.29
3	1.0100	10.56	1.0201	8.45	1.0305	7.29
4	1.0705	10.56	1.0710	8.45	1.0720	7.29
5	1.0805	10.56	1.0807	8.45	1.0810	7.29
6	1.0082	10.56	1.0286	8.45	1.0390	7.29
7	1.0466	10.56	1.0468	8.45	1.0472	7.29

8	1.0300	10.56	1.0304	8.45	1.0310	7.29
9	1.0398	10.56	1.0399	8.45	1.0402	7.29
10	1.0356	10.56	1.0359	8.45	1.0363	7.29
11	1.0491	10.56	1.0496	8.45	1.0501	7.29
12	1.0468	10.56	1.0467	8.45	1.0471	7.29
13	1.0433	10.56	1.0432	8.45	1.0434	7.29

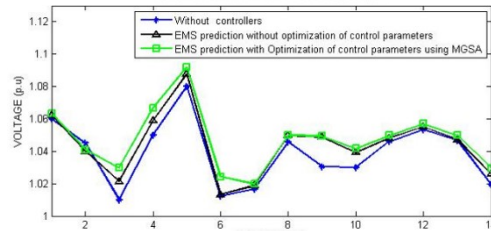
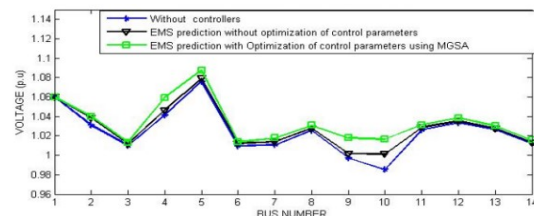

Figure 3 Voltage profile for IEEE14 bus system for case 1

In addition to earlier technique an optimization of control parameters using proposed DGSA is combined in BUS NUMBER EMS, the load flow simulation results after optimization the control parameters of controllers, show significant improvement of voltage profile in the overall system which decreases the active power losses in the system.

Table 4 Simulation results of voltage profile and active power losses for IEEE 14 bus system for case



3 with different preceding methods.

Figure 4 Voltage profile for IEEE14 bus system for case 2

The proposed DGSA has a faster convergence due to the applicability of hybrid algorithms. The proposed method is studied and tested on IEEE 14 bus test system. The system is mainly studied for improvement of voltage profile and thereby decreasing the active power losses in the line with the EMS. To validate the effectiveness of the proposed methodology using the proposed MGSA, it is compared with earlier literature studies with GA.

A comparative study of active power and voltage profile for the proposed MGSA and existing algorithms is tabulated in Table 4.

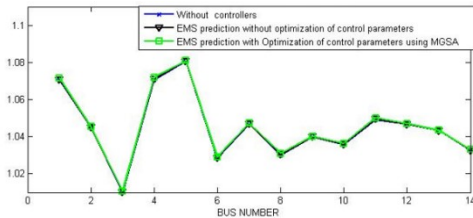

Fig 5 Voltage profile for IEEE14 bus system for case 3

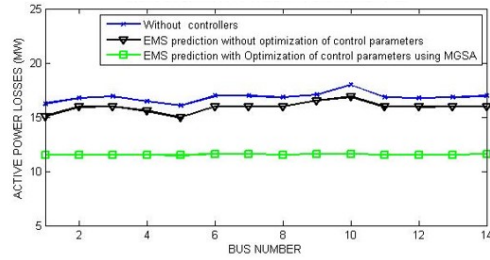

Fig 6 Active power loss profile for IEEE14 bus system for case 2

Table 4 Comparison of computation time with existing and proposed approach for different cases

S/N	Approach Employed	Computation time in sec for IEEE 14 bus system			Computation time in sec for IEEE 30 bus system		
		Case-1	Case-2	Case-3	Case-1	Case-2	Case-3
1	NPSO Benabid et al (2009)	16.98	17.25	15.26	18.67	19.25	17.95
2	GA Bagriyanik et al (2003)	14.65	17.02	14.02	16.46	19.98	16.20
3	<b>Proposed Approach MGSA</b>	<b>10.92</b>	<b>11.06</b>	<b>9.86</b>	<b>11.23</b>	<b>11.95</b>	<b>10.8</b>



The results depict clearly the effect of hybridization with addition of modification factor in the proposed MGSA helps the controllers to improve the voltage profile of the system there by reducing the active power losses in the line. Radically three test cases are studied on IEEE 14 bus and. In test cases, the system is allowed to operate at different loading conditions, along with the proposed technique by optimizing the control parameters using the proposed MGSA. Later the voltage profile and active power losses are governed for all test cases in IEEE 14 bus system.

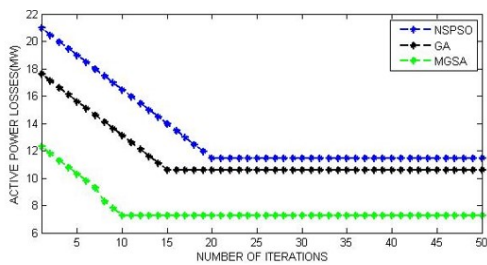

Figure 7 Active power loss profile for IEEE14 bus system for case 3

For IEEE 14 bus system, Figure 3 and Figure 5 shows the effectiveness of the proposed technique with MGSA, which depicts that the voltage profile has increased when compared to the other existing methodology. Figure 4 and Figure 7 characterizes the potency of the proposed algorithm by comparing it to conventional optimizing techniques, the results show that the proposed MGSA achieves better convergence characteristics providing the efficiency of the proposed MGSA. Figure 6 shows the active power losses profile for case 2 in IEEE 14 bus system, the results indulges by using the proposed technique along with proposed MGSA the active power losses in the system are decreased firmly.

The depicted results prove that the proposed MGSA give better solution and reduces active power losses in comparison with the earlier methods.

## VI. CONCLUSION

In this work the proposed model is developed with considering the power system constraints, mainly two real time constraint voltage constraints and active

Bus number	Without controllers using conventional method Tso et al (1997)		Power flow without optimization of EMS control parameters		Power flow with optimization of EMS control parameters using proposed DGSA approach	
	profile (p.u)	power losses (MW)	profile (p.u) Active	power losses (MW)	Voltage profile (p.u)	power losses (MW)
1	1.0600	16.23	1.0600	15.07	1.0601	11.50
2	1.0310	16.75	1.0387	15.95	1.0398	11.50
3	1.0100	16.92	1.0120	15.97	1.0132	11.50
4	1.0413	16.46	1.0463	15.56	1.0593	11.50
5	1.0763	16.07	1.0793	14.96	1.0878	11.48
6	1.0098	16.96	1.0122	15.97	1.0137	11.58
7	1.0109	16.96	1.0139	15.97	1.0178	11.58
8	1.0257	16.82	1.0278	15.97	1.0308	11.50
9	0.9972	17.05	1.0018	16.52	1.0178	11.58
10	0.9853	17.96	1.0012	16.86	1.0167	11.58
11	1.0261	16.82	1.0287	15.95	1.0315	11.50
12	1.0334	16.75	1.0354	15.95	1.0387	11.50
13	1.0266	16.82	1.0276	15.97	1.0301	11.50
14	1.0122	16.96	1.0134	15.97	1.0158	11.58

power flow is taken into account to formulate an EMS for forecasting the energy. The energy



management problem at each time independently focuses on solving the proposed model as a multi objective optimization problem. The energy management is proposed in this work is through optimal power flow with system operational constraints such as active power and voltage stability of the bus system this comprises to frame an objective function to solve proposed multi objective optimization problem. Here in this work the proposed optimization problem is solved using proposed MGSA, the proposed algorithm finds the optimal values for the objective function, which in turn deduces the proposed EMS to work in an economical model. In the proposed EMS work the active power losses are reduced by optimizing the control parameters using the proposed algorithm. To the replicate the real time problem three test cases are studied in the simulation. To show the effectiveness of the proposed algorithm results are compared with existing optimization techniques for same proposed model. Thus the overall objective of building an EMS by forecasting the optimal power flow, maintain the voltage stability and thereby reducing the active power losses is achieved. These operational constraints when annexed with real time power system achieve an EMS at a cost of economic model which will serve the desired objective of the work.

#### REFERENCES

- [1] Wenbo Shi, Student Member, IEEE, Na Li, Member, IEEE, Chi-Cheng Chu, and RajitGadh, "Real-Time Energy Management in Microgrids", IEEE Transactions On Smart Grid, Vol. 8, No. 1, January 2017
- [2] Pappalexopoulus A. D. and Hesterberg T. C., "A regression based approach to short term load forecasting", IEEE Transactions on Power Systems, Vol. 5, No. 4, pp. 1535-1547, 1990.
- [3] Haida T. and Muto S., "Regression based peak load forecasting using a transformation technique", IEEE Transactions on Power Systems, Vol. 9, No.4, pp. 1788–1794, Nov.1994.
- [4] Hyde O. and Hodnett P. F., "An adaptable automated procedure for short term electricity load forecasting," IEEE Transactions on Power Systems, Vol. 12, No. 1, pp.84-94, 1997.
- [5] Charytonuik W., Chen M. S., Van Olinda P., "Non-Parametric regression based short term load Forecasting", IEEE Transactions on Power Systems, Vol. 13, No. 3, pp. 725-730, 1998.
- [6] Ruzic S., Vuckovic A. and Nikolic N., "Weather sensitive method for short term load forecasting in electric power utility of Serbia", IEEE Transactions on Power Systems, Vol. 18, Issue 4, pp. 1581-1586, 2003.
- [7] Amjady N., "Short term hourly load forecasting using time series modeling with peak load estimation capability", IEEE Transactions on Power Systems, Vol. 16, No.4, pp. 798-805, Nov. 2011.
- [8] Fan J. Y. and Mc Donald J. D., "A real-time implementation of short term load forecasting for distribution power systems", IEEE Transactions on Power Systems, Vol. 9, Issue 2, pp. 988–994, 1994.
- [9] Yang H. T., Huang C. M. and Huang C. L., "Identification of ARMAX model for short term load forecasting, An evolutionary programming approach", IEEE Transactions on Power Systems, Vol. 11, Issue 1, pp. 403–408, 1996.
- [10] Yang H. T. and Huang C. M., "A new short term load forecasting approach using self-organizing fuzzy ARMAX models", IEEE Transactions on Power Systems, Vol.13, Issue 1, pp. 217-225, 1998.
- [11] Norlina MohdSabri ;MazidahPuteh ; Mohamad Rusop Mahmood., "An overview of Gravitational Search Algorithm utilization in optimization problems", IEEE Transactions on Power Systems, Vol. 2, No. 3, pp. 785-791, 2015.
- [12] Espinoza M., Joye C. and Belmans R., "Short term load forecasting, profile identification and customer segmentation: A methodology based on periodic time series", IEEE Transactions on Power Systems, Vol. 20, No. 3, pp. 1622-1631, 2015.
- [13] Huang C. M., Huang C. J., and Wang M. L., "A particle swarm optimization to identifying the ARMAX model for short term load forecasting", IEEE Transactions on Power Systems, Vol. 20, No. 2, pp. 1126-1133, 2016.
- [14] Huang S.-J. and Shih K.-R., "Short term load forecasting via ARMA model identification including non-Gaussian process considerations", IEEE

- Transactions on Power Systems, Vol. 18, Issue 2, pp. 673-679, 2017.
- [15] Peng M., Hubele N. F. and Karady G. G., "Advancement in the application of neural networks for short term load forecasting", IEEE Transactions on Power Systems, Vol. 7, Issue 1, pp. 250-257, 1992.
- [16] Xu R. and Wunsch D., "Survey of clustering algorithms", IEEE Transactions on Neural Networks, Vol. 16, No. 3, pp. 645-678, 2005.
- [17] Chen J. F., Wang W. M. and Huang C.-M., "Analysis of an adaptive time series Auto Regressive Moving Average (ARMA) model for short term load forecasting", Electric Power Systems Research, Vol. 34, Issue 3, pp. 187-196, 1995.
- [18] Cho M. Y., Hwang J. C. and Chen C. S., "Customer short term load forecasting by using ARIMA transfer function model", Proceedings of the International Conference on Energy Management and Power Delivery (EMPD), Vol. 1, pp. 317-322, 1995.
- [19] Gross G. and Galiana F. D., "Short term load forecasting", Proceedings of the IEEE, Vol. 75, No. 2, pp. 1558-1573, 1987.
- [20] Taylor J. W., de Menezes L. M. and McSharry P. E., "A comparison of univariate methods for forecasting electricity demand up to a day ahead", International Journal of Forecasting, Vol. 22, Issue 1, pp. 1-16, 2017.
- [21] Feinberg E. A. and Genethliou D., "Load forecasting", Chapter in Applied Mathematics for Restructured Electric Power Systems, Optimization, Control, and Computational Intelligence, J. H. Chow et al. (eds.), Springer, 2015.
- [22] Philippe Lauret, Eric Fock, Rija N. Randrianarivony and Jean-Francois Manicom Ramsamy, "Bayesian neural approach to short time load forecasting", Energy Conversion and Management, Vol. 49, Issue 5, pp. 1156-1166, May 2008.
- [23] Engle R. F., Mustafa C. and Rice J., "Modeling peak electricity demand", Journal of Forecasting, Vol. 11, Issue 3, pp. 241-251, April 1992.
- [24] Flexer A., "On the use of self-organizing Maps for clustering and visualization", Intelligent Data Analysis, Vol. 5, No. 5, pp. 373-384, 2001.
- [25] Morgen E. Peck, A Microgrid Grows in Brooklyn, ScientificAmerican.com, April 22, 2016. Available at

<http://www.scientificamerican.com/article/a-microgrid-grows-inbrooklyn/>