

Monitoring and Prevention of Fuel Theft using Password Authentication

S.SIVARANJANI¹, K.SWAATHY², B.SWAPANALI³, D.VIMALA⁴

Department of Electronics and Communication Engineering, Sri Ramakrishna Institute of Technology, Coimbatore

Abstract- Fuel theft has become a major concern for gas station owners. It is mostly done by irresponsible drivers when they transport the fuel from terminal to gas stations. The proposed system is used to prevent this theft. The system consists of Arduino, GSM, GPS and flowmeter. This system will keep track of oil distribution from oil terminal to gas station, gas station to gas station and then return to oil terminal. The destination codes for the station for which the fuel is to be delivered is entered through the keyboard when the truck leaves the station. The one-time password will be generated and transmitted to the respective destination owners whose destination codes are entered. When the truck reaches the destination, the password received by that owner should be entered to open the bottom loader of the truck. The valve can't be opened, if the password is entered wrongly. During this circumstance's owner will receive an alert message along with the location of the truck. This application is useful to reduce fuel scarcity due to fuel hoarding and potentially help the owners from financial losses with the help of this simple and cost-efficient system. This system provides a better security system and prevents fuel theft.

Keywords- GSM, LCD, Flow meter, GPS module, Electronic valve.

I. INTRODUCTION

There is a lot of news regarding the illegal fuel hoarding and fuel thefts which leads to corruption. Our daily life mainly depends on transportation which is highly based on fuels. India is the third biggest oil importer after US and China in 2017. India imports 82% of its oil needs. India generates 35.2 million tons of petroleum products from indigenous crude oil production whereas the consumption of petroleum products is 204.9 million tons. Due to lack of adequate petroleum reserves, India has to depend mostly on crude oil imports. The economic value of the country highly depends on this import of fuels, as the value of crude oil production alone is worth a staggering \$1.7 trillion each year. Billions of dollars

per year of government and corporate revenues are lost due to fuel theft. The impact of fuel theft on people and economy is significant and wide ranging. The majority of transport vehicles are powered by traditional petroleum fuel such as gasoline, octane, diesel etc. In 2017, oil reserves in India amounted to around 0.6 billion metric tons. BP's annual report states that with current rate of extraction the country will only survive for next 40 years. This problem is faced by many other countries. This is made even worse by fuel theft. These days the fuel theft has increased drastically, and it happened when the oil price is skyrocketed suddenly. It is estimated that between 2,00,000 and 3,00,000 barrels of oil is lost daily to theft. Fuel is one of the most significant targets of thieves these days because it is easy to use and sell. It is noted that most of the oil theft occurs due to irresponsible drivers during transportation from oil terminal to gas station or gas station to gas station. Illegal fuel hoarding are usually done by simply open the bottom loader trunk then with a little tricks, the valve can be opened without damaging the seal. Fleet owners have to do something about it in order to reduce increased fuel loss. Many technologies were introduced to prevent this theft, but it has proved ineffectiveness. The proposed methodology is used to prevent these thefts by using password authentication method. This methodology involves opening of the valve using password. Thus, preventing the fuel theft.

II. IDEAS AND RESEARCHES

The fuel theft is currently detected by a method in which, when the truck leaves the terminal the destination codes for respective destination to which the fuel is to be supplied is provided. The destination codes are entered, and random numbers are generated as passwords to respective owners. The valve can be opened even when the password is incorrect. Here the password is mainly used for verification rather than

prevention. The proposed methodology is mainly concerned with prevention.

III. ANALYSIS

From the research of our project, we found that in the existing system the password is used to determine that the driver has reached the destination or not. If the entered password is wrong, then an alert message is sent to the fuel terminal owner. If the entered password is correct, then the valve opens. But without entering the password also, the valve of the fuel tank can be opened. This drawback can be rectified by following the proposed methodology.

IV. PROPOSED METHODOLOGY

A. Description

Illegal fuel hoarding is done by irresponsible drivers when they transport the fuel from fuel terminal to the gas stations. The truck fills the fuel to the tank in the filling shed of the fuel terminal. The driver gets the gas stations list, once the truck leaves the gate of the fuel terminal for transportation of fuels. The random passwords are generated and sent to each destination stations through GSM. A password is sent only to the destination owners. After reaching the destination, the driver enters the destination code. The driver gets the password from the gas station destination owner to open the electronic valve. If the driver enters the correct password, then the electronic valve opens. If the entered password is wrong, then an alert message is sent to the fuel terminal owner along with the location of the truck using GPS. If the electronic valve opens, then the fuel from the tank are filled to the gas stations. Then the flowmeter is used to measure the flow of the fuel from the tank and send a message to the fuel terminal owner about the amount of fuel supplied to that destination. Then it checks whether it is the last destination or not. If it is not the last decision, then the process continues. If it is the last decision, then the truck returns to the fuel terminal.

B. GSM

The GSM module is used to send SMS to programmed mobile numbers. The random passwords are generated daily when the truck leaves the fuel terminal and sent to the each destination owners via GSM. If the entered password is wrong then an alert message is sent to the Fuel terminal owner.

C. Block Diagram

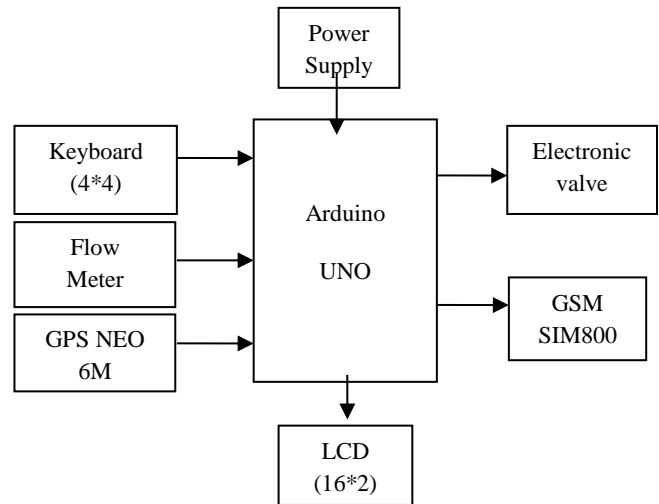

Fig.1. Block Diagram of the proposed system.

D. Electronic valve

The solenoid valve is a electromechanical device in which the solenoid uses an electric current to generate a magnetic field and thereby operate a mechanism which regulates the opening of fluid flow in the valve. If the password entered in the keypad is correct then the electronic valve opens.

E. Flow Meter

Flow meter is a device used to measure the volume or mass of a gas or liquid. Here it is used to measure the flow or outcome of the fuel from the fuel tank and send a message about the supply of fuel to the fuel terminal owner through GSM.

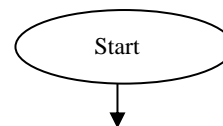

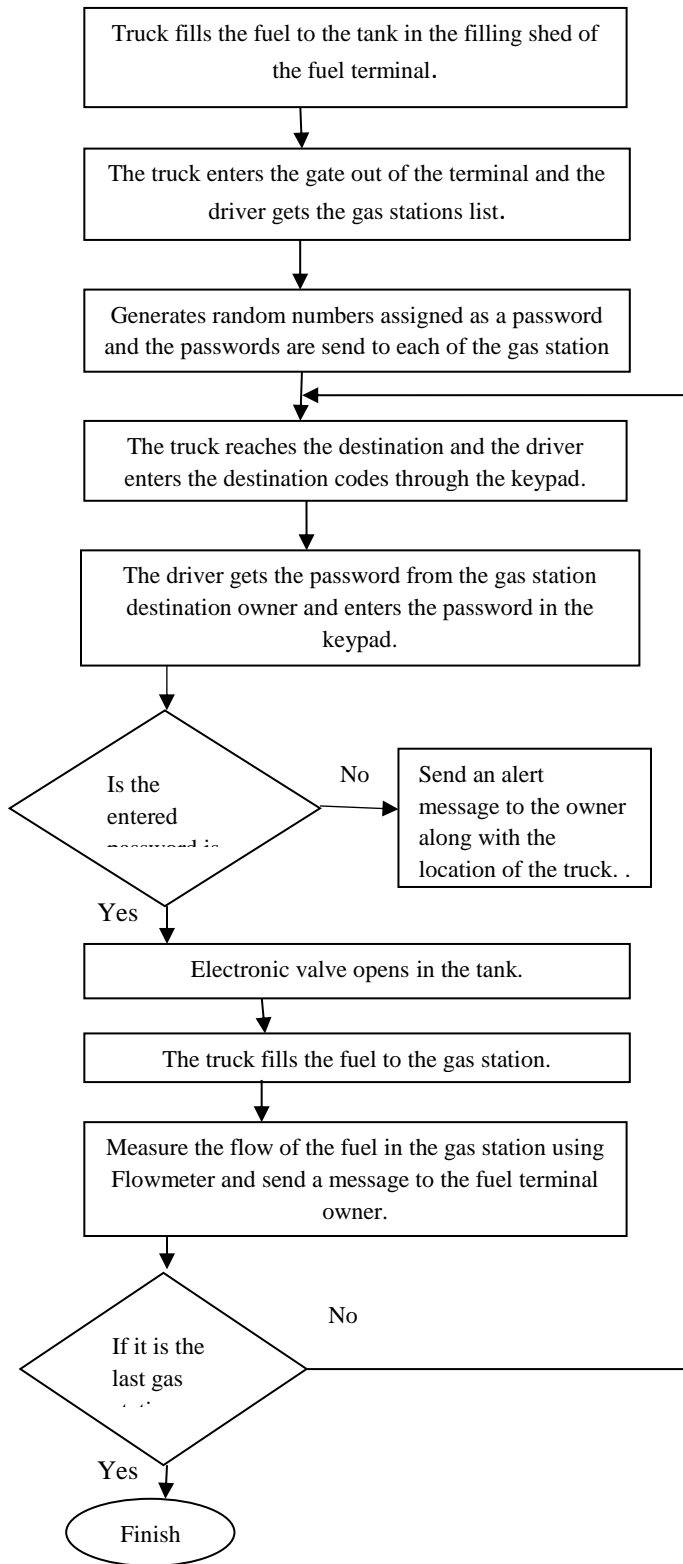

Fig.2. Flowchart.

F. Use of Software

The code is based on embedded C programming language and the software used is Arduino 1.8.5. The surveying shows that there are many fuel thefts are done by irresponsible drivers. So a algorithm is written based on that. Whenever the truck leaves the terminal number of destination and destination code will be entered. The random numbers are generated as passwords to each destination. When the truck reaches the destination the respective destination code is entered along with the password. If the password is correct the valve can be opened, and amount of fuel supply is measured. If the password is wrong the warning message will be sent to the terminal. The code contains these steps for implementation.

V. RESULTS

The controller used in the proposed methodology is Arduino UNO. The results of the methodology is shown below.

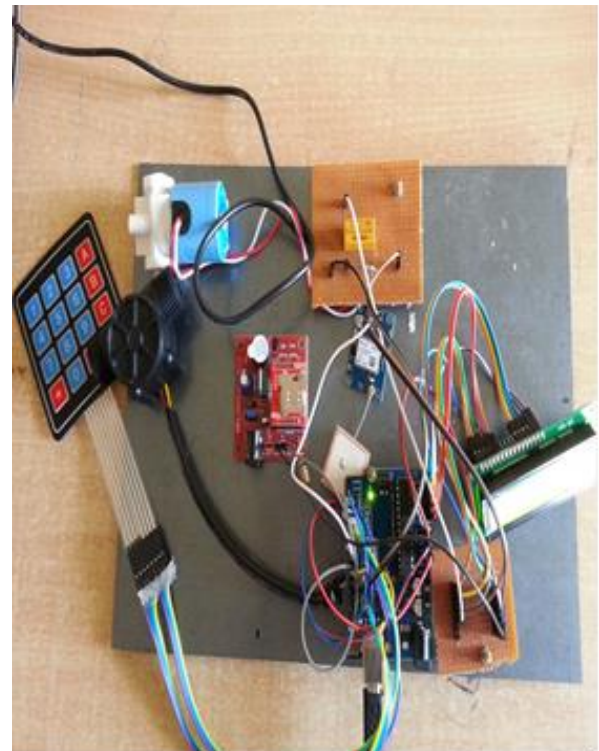

Fig.3. Monitoring and prevention of fuel theft using passord authentication

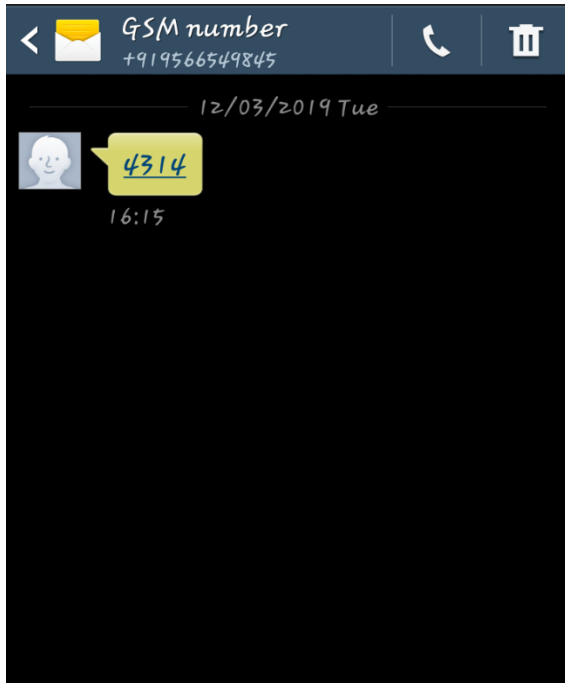

Fig.4. A random number is sent as a message

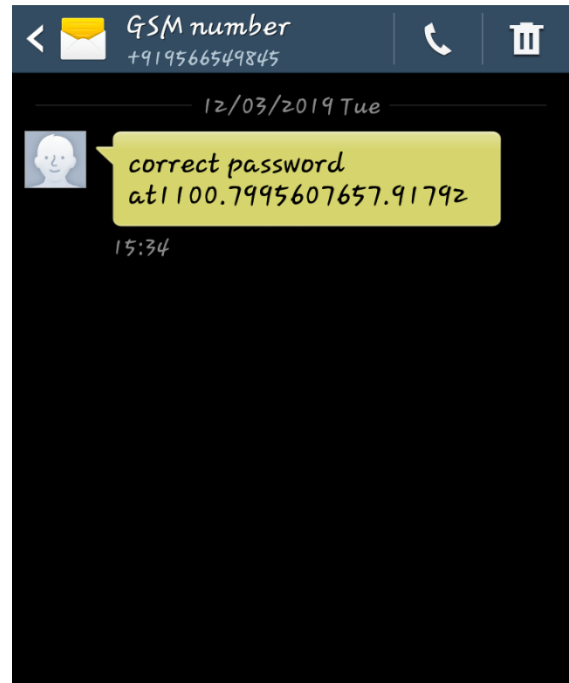

Fig.6. Message sent via GSM when the right password is entered

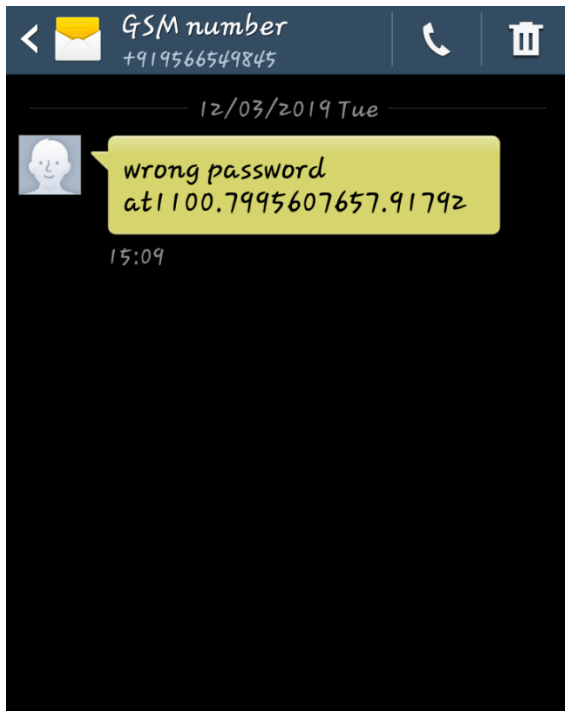

Fig.5. Message sent via GSM when the wrong password is entered

VI. CONCLUSION

In the proposed methodology the hoarding can be detected and prevented as the valve can only be opened when the password is correct. Whereas in existing system the theft can only be detected not prevented. The system has many advantages such as large capability, low operation costs, effective and easy to use in vehicles which carry liquids.

VII. FUTURE WORK

For future work, this system can be further developed by the use of camera and by developing a mobile based application to get the real time view of the vehicle, which would be more convenient for the vehicle or fuel terminal owner to track the people who are all involved in the fuel hoarding. It is useful as an evidence for the fuel terminal owner if the illegal fuel hoarding occurs.

ACKNOWLEDGMENT

We highly indebted to our Principal Dr. M. Paulraj for their guidance, valuable suggestions and

sustained encouragement for successful completion of this project.

We profoundly thankful to, Professor & Head, Department of Electronics and Communication Engineering Dr. H. Mangalam and Project coordinator Mr. T. Joby Titus Assistant Professor (Sr. Gr), Department of Electronics and Communication Engineering for their consistent encouragement and directions to improve our Project and completing our Project work in time.

We take immense pleasure in expressing my humble note of thankfulness to my project guide Ms. D. Vimala Assistant Professor, Department of Electronics and Communication Engineering, for her exemplary guidance and valuable suggestions, which helped us in effectively developing our Project.

We also extend our thanks to our faculty members, family members and friends for their motivation and moral support towards successfully accomplish this Project.

REFERENCES

- [1] R. Navitha Devi, R.S. Prathap singh, "Arduino Based Oil Truck Alarm System for Illegal Fuel Hoarding Using GSM Module", International Journal of Advanced Technology and Innovative Research, ISSN Vol.10, Issue.07, July-2018.
- [2] R.Senthil Kumar, M.Ganapathi, D.Arunkumar, G.Goutham, M.Karthick, "Fuel Monitoring System For Fuel Management" International Journal of Science, Engineering and Technology Research (IJSETR), Volume 6, Issue 4, ISSN: 2278 -7798, April 2017.
- [3] G.Bhavani, L.Anitha , M.Anitha, T.Gayathri, "Automatic Oil Tank Truck Alarm System from Illegal Fuel Hoarding with Microcontroller and GSM module based system", International Journal of Advanced Research in Basic Engineering Sciences an Technology (IJARBEST), Vol. 3, Special Issue 34, March 2017.
- [4] S.Baskaran, J.Mohana Krishnan, S.Muthukumar, M.Selvaganapathy, "Design and Implementation of a Wi-Fi Based Encryption System" International Journal of Advanced Research in Basic Engineering Sciences and Technology (IJARBEST), ISSN: 2456-5717 Vol. 3, Special Issue 34, March 2017.
- [5] B.Sudharshana, Sushmita Reena Jacob, S.Sukambika, "Automatic Oil tank Truck Alarm System for Fuel Theft Prevention", IJARIE-ISSN (O)-2395-43964450, Vol-3, Issue- 3, 2017.
- [6] Manisha Rinait, NainaTarpe, Priyanka Gadewa, Ganesh Barde, Akshay Mohurle, Suchita, S. Kamble, "Vehicle Fuel Monitoring and Theft Detection System with SMS Indication using GSM" Journal of VLSI Design and Signal Processing Volume 3 Issue 1, MAT Journals 2017.
- [7] P. Senthil Raja, B.G. Geetha, "Detection of Fuel Theft in Heavy Vehicle" International Journal of Advanced Engineering Technology E-ISSN 0976-3945, Vol. VII/Issue II, April-June, 2016.
- [8] Samarth Viswanath, Marco Belcastro, John Barton, Brendan O'Flynn, Nicholas Holmes, Paul Dixon, "Low-power Wireless Liquid monitoring system using Ultrasonic sensors" International Journal on Smart Sensing and Intelligent Systems, Vol. 8, No. 1, March 2015.
- [9] Muhammad Fikko Fadjrimiratno, Andrey Wicaksono, Rofiq Cahyo Prayogo, Hot Asi Yohannes Sidabutar, and Sumardi, "Automatic Oil Tank Truck Alarm System From Illegal Fuel Hoarding With Microcontroller And GSM Module Based System", DIKTI and PERTAMINA Research, IEEE 2015.
- [10] P. Senthilraja, C.Rukumani Khandhan, M. Padaniappan, J. Vinumathi, S.L.Rama, P. Sai Sushimitha, R. Madhan, "Detection Of Fuel Theft And Vehicle Position With Third Party Monitoring Software" International Journal of Advanced Computational Engineering and Networking, ISSN:2320-2106 Volume- 1, Issue-7, Sept-2013.