

Signal Behaviours of Power Transmission Line During Fault

OLUTOYE S. ¹, EZECHUKWU O. A. ²

^{1,2} *Department of Electrical Engineering, Nnamdi Azikiwe University, Awka, Anambra State.*

Abstract- *The consumption of electrical energy has continued to be on increase, following industrial, commercial and population growth. In order to supply constant power to consumers, reliability is an important factor that the electric utility needs to consider. Common disturbances on transmission lines resulting to different faults do affect the stability of electricity supply. Thus, this paper seeks to demonstrate the signal behaviours of power transmission line owing to disruptions caused by different categories of fault. The approach adopted here consists of using Simscape Power Systems tool available in Simulink environment to model 330kv transmission line and its simulation aided the sampling of voltage and current waveforms in transmission network on occurrence of various fault types. The results of the simulation tests indicated that the approach is reliable for identification of signal behaviour of a faulted transmission line.*

Indexed Terms: *Transmission line, behaviour, current and voltage waveforms, symmetrical faults unsymmetrical faults*

I. INTRODUCTION

Power transmission and distribution lines are the vital links that achieve the essential continuity of service of electrical power to the end users (Mohammad Abdul Baseer, 2013).

Transmission lines shield against uncovered deficiency is the most basic errand in the assurance of power system. Faults in overhead lines are unusual conditions brought by natural and climate conditions, human errors and so on. These problems are hazardous to the congruity of power supply. Fault is nothing but an abnormal condition (Isa S. Qamber, 2017). In power transmission systems, the system quantities (current, voltage, phase angle etc) experience abnormal changes in their values whenever the system faces an abnormal condition, called fault. The overhead transmission line is exposed to atmospheric and natural conditions, so the chances of

faults occurrence are more compared to underground cables.

Simulating the model of power system has become a necessity when there is fault, in order to make right decisions, check for any potential problems and fault conditions in large interconnected network (R. S. Meena and M. K. Lodha, 2015).

Hence, there is need to demonstrate the behaviours of voltage and current signals on faulty transmission line. It is well known that induction motor loads have a particular hazardous role in the voltage stability. Configuration changes such as line tripping may cause voltage collapse. Moreover, if there is a fault on transmission line, the disturbance effect will then significantly increase the possibility of voltage collapse.

II. POWER SYSTEM FAULTS

Fault in overhead transmission system can be classified into two types, i.e. series (open conductor) faults and shunt (short-circuit) faults (Avagaddi Prasad, J. Belwin Edward and K. Ravi, 2017). Series faults can be identified easily by observing the value of each phase voltage. If the voltage value is zero, it indicates that open conductor fault has occurred. And if the current value increases, it indicates that short circuit fault has occurred. Short circuit faults are divided into two types, i.e. asymmetrical and symmetrical faults. Asymmetrical faults include line to ground, (LG), line-to-line (LL), and double line to ground (LLG), symmetrical faults are triple line (LLL) and triple line to ground (LLLG) faults. Figure1 shows the classification of faults in overhead transmission system, in this figure A-C and G indicate phase A, phase B, phase C and ground respectively.

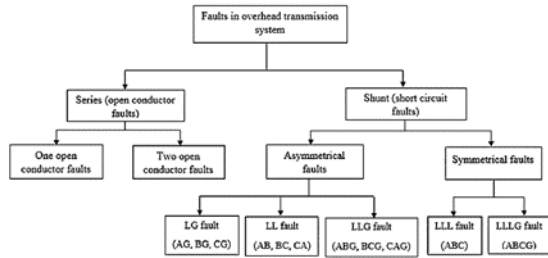

Figure 1: Classification of Faults

2.1 Nature and causes of faults

Faults are caused by either insulation failures or conducting path failures. Most of the faults on transmission and distribution lines are caused by over voltage due to lightning and switching surges or by external conducting objects falling on overhead lines (Mohammad Abdul Baseer, 2013). Birds, tree branches may also cause faults on overhead lines. Other causes of faults on overhead lines are direct lightning stroke, aircraft, snakes, ice and snow loading, storms, earthquakes, creepers etc. In the case of cables, transformers and generators causes may be by failure of solid insulation due to ageing, heat, moisture or over voltage, accidental contact with earth etc.

2.2 Effects of faults

A fault if unlearned can cause the following effects on a power system.

Heavy short circuit may cause damage to equipment or any other element of the power system due to over heating or flashover and high mechanical forces set up due to heavy current.

There may be reduction in the supply voltage of the healthy feeders, resulting in the loss of industrial loads. Short circuits may cause the unbalancing of the supply voltages and currents, thereby heating rotating machines.

There may be a loss of system stability. The faults may cause an interruption of supply to consumers.

III. TYPES OF TRANSMISSION LINE FAULTS

The following are the most common types of shunt faults:

3.1 Single Line-To-Ground Fault This type of fault occurs when one conductor makes contacts with the neutral wire or ground. It could also be as a result of falling trees in a rainy storm. This type could be represented as shown in the Figure 2 below.

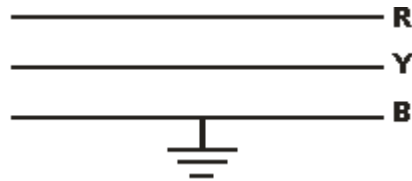

Figure 2: Single Line-to-Ground Fault

3.2 Line-To-Line Fault

This is said to occur when two transmission lines are short-circuited. As in the case of a large bird standing on one transmission line and touching the other or if a tree branch happens to fall on top of two power transmission lines. This type could be represented as shown in the Figure 3 below.

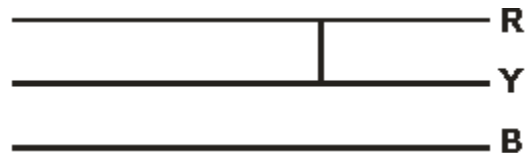

Figure 3: Line-to-Line Fault

3.3 Double Line-To-Ground Fault This can as be a result of a tree falling on two of the power lines and still makes contact with earth or neutral line. This type could be represented as shown in the Figure 4 below.

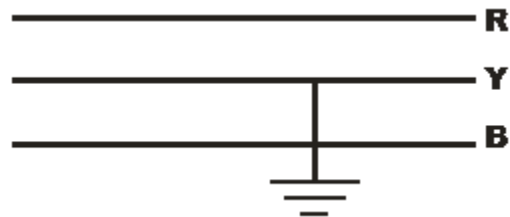

Figure 4: Double Line-to-Ground Fault

3.4 Balanced Three-Phase Fault: This can occur when the three power lines make contact in many different forms. This type could be represented as shown in figure 5 below.

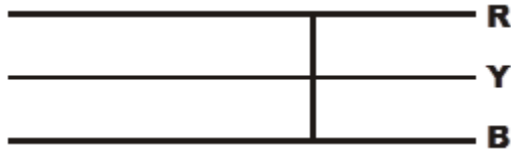

Figure 5: Balance Three Phase-to-Ground Fault

IV. SINGLE LINE DIAGRAM OF A THREE-PHASE TRANSMISSION LINE

A single line diagram of a three-phase transmission line system having two generators is shown in Figure 6. Phasor voltage and current are assumed to be available from both ends of the single transmission line. This method is suitable for transposed and untransposed transmission lines. It does not depend on fault resistance and source impedance.

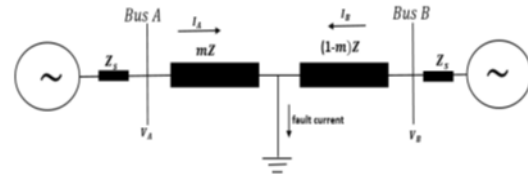

Figure 6: Faulted Three-phase Transmission Line

V. DESCRIPTION OF THE SIMULATION MODEL

The transmission line has been modelled using distributed parameters so that it accurately describes a long transmission line. A snapshot of the model used for obtaining the data sets is as shown in Figure 7. In this Figure 7, Z1 and Z2 are the source impedances of the generators on either side. The three-phase V - I measurement block is used to measure the voltage and current samples at the terminal B. The transmission line (Line 1 and Line 2 together) are 100km long and three-phase fault block is used to inject various types of faults at varying locations along the transmission line with different fault resistances.

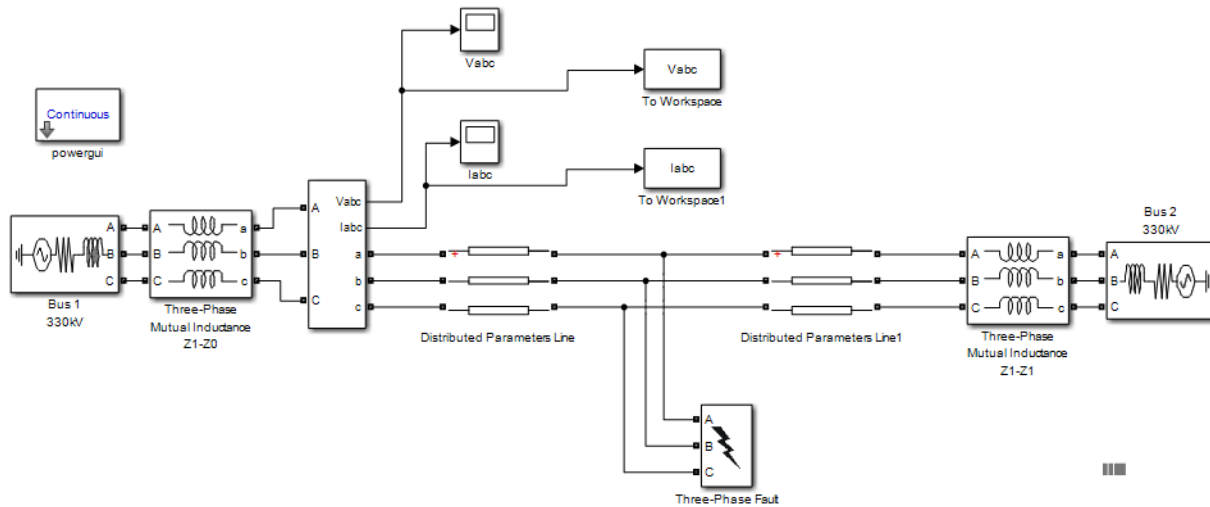

Figure 7: Simulation Model of Faulted Three-Phase Transmission Line

VI. SIMULATION TEST

Simulation was repeatedly carried out in the Simulink environment for various types of fault injected into the transmission line model. The total length of the

transmission line between Bus 1 and Bus 2 is 100 kilometers. The various fault types were initiated at 30km away from Bus 2. The voltage and current waveforms were sampled between 0.05s and 0.18s and their magnitudes at both ends of the transmission line were measured and recorded.

VII. GENERATED WAVEFORMS

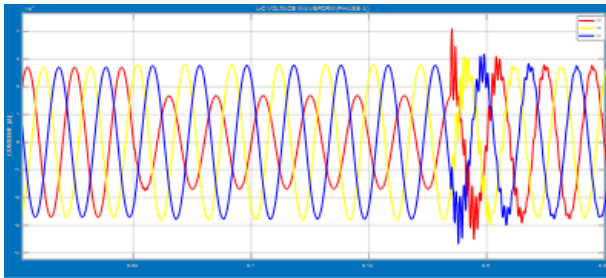

Figure 8: L-G Voltage Waveform (Phase A).

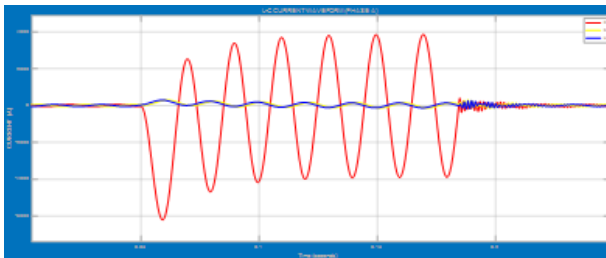

Figure 9: L-G Current Waveform (Phase A).

Figures 8 and 9 depict the voltage waveform and the current waveform respectively during the occurrence of single line to ground fault on phase A. When fault was initiated on the transmission line between 0.05s and 0.18s at 30km away from Bus 2, the current waveform and the bus voltage waveform were stable until fault occurred. Hence, the voltage decreased and the current increased leading to an unhealthy network. As soon as the fault duration elapsed, the voltage waveform and current waveform become stable.

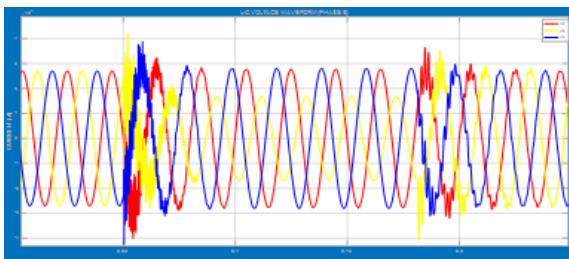

Figure 10: L-G Voltage Waveform (Phase B).

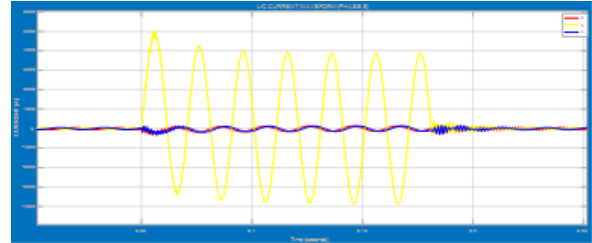

Figure 11: L-G Current Waveform (Phase B).

Figures 10 and 11 depict the voltage waveform and the current waveform respectively during the occurrence of single line to ground fault on phase B. When fault was initiated on the transmission line between 0.05s and 0.18s at 30km away from Bus 2, the current waveform and the bus voltage waveform were stable until fault occurred. Hence, the voltage decreased and the current increased leading to an unhealthy network. As soon as the fault duration elapsed, the voltage waveform and current waveform become stable.

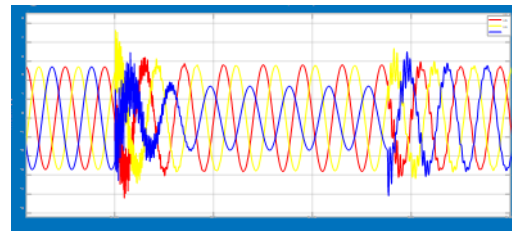

Figure 12: L-G Voltage Waveform (Phase C).

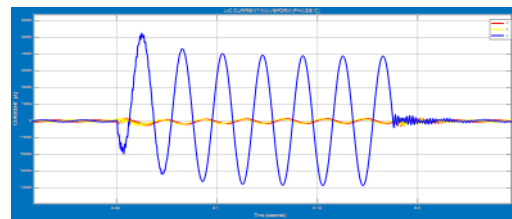

Figure 13: L-G Current Waveform (Phase C).

Figures 12 and 13 depict the voltage waveform and the current waveform respectively during the occurrence of single line to ground fault on phase C. When fault was initiated on the transmission line between 0.05s and 0.18s at 30km away from Bus 2, the current waveform and the bus voltage waveform were stable until fault occurred. Hence, the voltage decreased and the current increased leading to an unhealthy network. As soon as the fault duration elapsed, the voltage waveform and current waveform become stable.

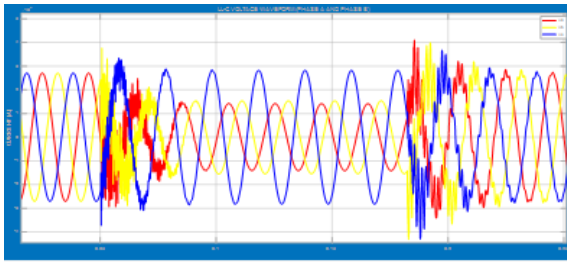

Figure 14: L-L-G Voltage Waveform (Phase A and B).

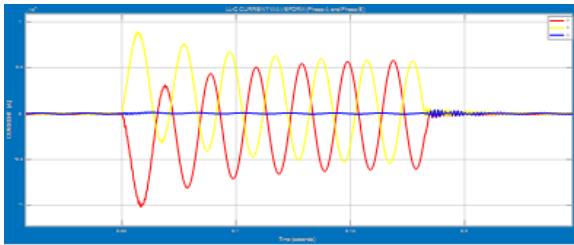

Figure 15: L-L-G Current Waveform (Phase A and B).

Figures 14 and 15 depict the voltage waveform and the current waveform respectively during the occurrence of double line to ground fault. The current waveform and the bus voltage waveform were stable until fault occurred at 30km away from Bus 2. Consequently, the voltage waveforms of phase A and B appeared to be lumped together and as well smaller than phase C. However, the current waveforms of phase A and B appeared swollen, which indicates an unhealthy network. As soon as the fault duration elapsed, the voltage and current waveforms become stable.

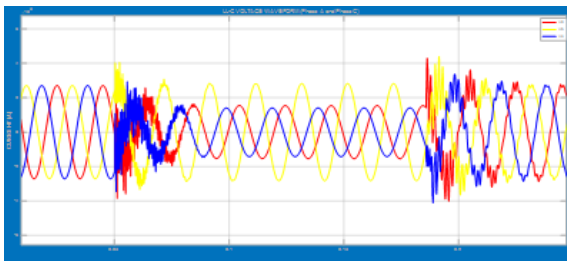

Figure 16: L-L-G Voltage Waveform (Phase A and C).

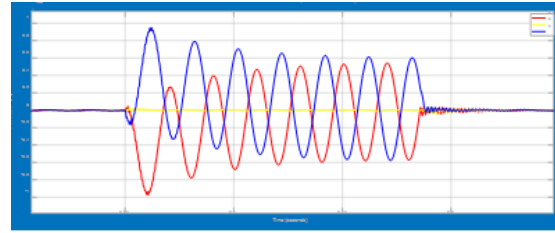

Figure 17: L-L-G Current Waveform (Phase A and C).

Figures 16 and 17 depict the voltage waveform and the current waveform respectively during the occurrence of double line to ground fault. The current waveform and the bus voltage waveform were stable until fault occurred at 30km away from Bus 2. Consequently, the voltage waveforms of phase A and C appeared to be lumped together and as well smaller than phase B. However, the current waveforms of phase A and C appeared swollen, which indicates an unhealthy network. As soon as the fault duration elapsed, the voltage and current waveforms become stable.

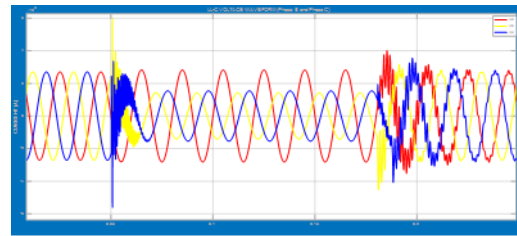

Figure 18: L-L-G Voltage Waveform (Phase B and C).

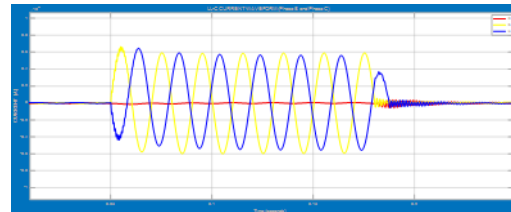

Figure 19: L-L-G Current Waveform (Phase B and C).

Figures 18 and 19 depict the voltage waveform and the current waveform respectively during the occurrence of double line to ground fault. The current waveform and the bus voltage waveform were stable until fault occurred at 30km away from Bus 2. Consequently, the voltage waveforms of phase B and C appeared to be lumped together and as well smaller than phase A. However, the current waveforms of phase B and C appeared swollen, which indicates an unhealthy

network. As soon as the fault duration elapsed, the voltage and current waveforms become stable.

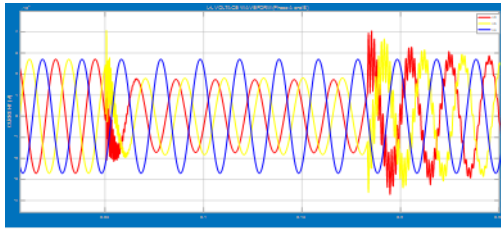

Figure 20: L-L Voltage Waveform (Phase A and B).

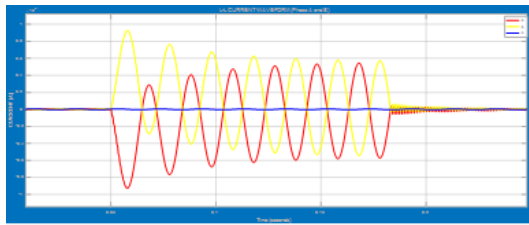

Figure 21: L-L Current Waveform (Phase A and B).

Figures 20 and 21 depict the voltage waveform and the current waveform respectively during the occurrence of double line fault. The current waveform and the bus voltage waveform were stable until fault occurred at 30km away from Bus 2. Consequently, the voltage waveforms of phase A and B appeared to be lumped together and as well smaller than phase C. However, the current waveforms of phase A and B appeared swollen, which indicates an unhealthy network. As soon as the fault duration elapsed, the voltage and current waveforms become stable.

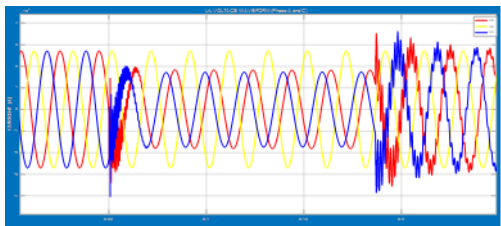

Figure 22: L-L Voltage Waveform (Phase A and C).

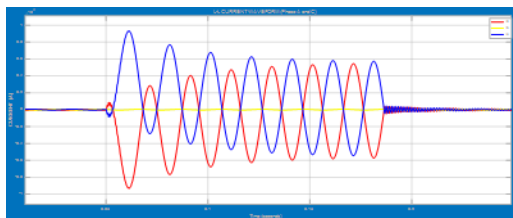

Figure 23: L-L Current Waveform (Phase A and C).

Figures 22 and 23 depict the voltage waveform and the current waveform respectively during the occurrence of double line fault. The current waveform and the bus voltage waveform were stable until fault occurred at 30km away from Bus 2. Consequently, the voltage waveforms of phase A and C appeared to be lumped together and as well smaller than phase B. However, the current waveforms of phase A and C appeared swollen, which indicates an unhealthy network. As soon as the fault duration elapsed, the voltage and current waveforms become stable.

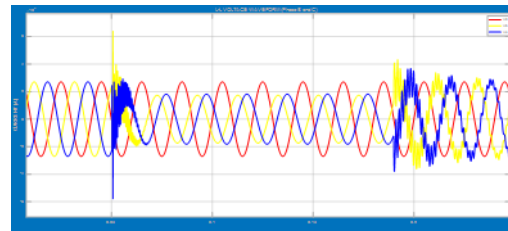

Figure 24: L-L Voltage Waveform (Phase B and C).

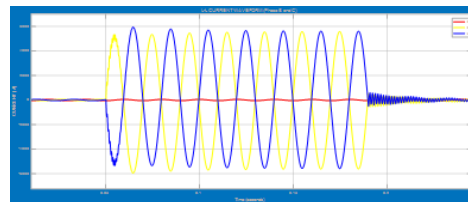

Figure 25: L-L Current Waveform (Phase B and C).

Figures 24 and 25 depict the voltage waveform and the current waveform respectively during the occurrence of double line fault. The current waveform and the bus voltage waveform were stable until fault occurred at 30km away from Bus 2. Consequently, the voltage waveforms of phase B and C appeared to be lumped together and as well smaller than phase A. However, the current waveforms of phase B and C appeared swollen, which indicates an unhealthy network. As soon as the fault duration elapsed, the voltage and current waveforms become stable.

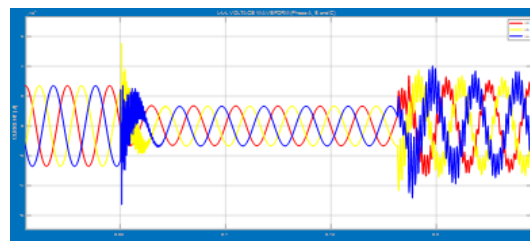

Figure 25: L-L-L-G Voltage Waveform (Phase A, B and C).

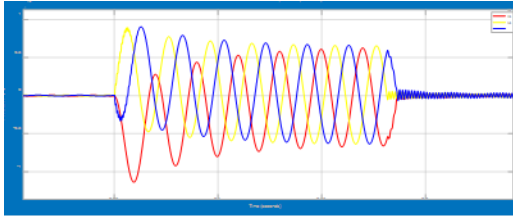

Figure 26: L-L-L-G Current Waveform (Phase A, B and C).

waveform and the current waveform at 30km away from Bus 2 respectively during the occurrence of three-phase to ground fault. The impact of faults on three-phase to ground is most severe as they all collapsed compared to other types of faults.

VIII. RESULTS

The three-phase current and voltage waveforms measured at both terminals during the occurrence of fault in the power transmission-line are as tabulated.

Figures 25 and 26 depict the voltage

Table1: Current and Voltage Measurements at Both Ends of The Transmission line

		BUS 1		BUS 2	
Type of Fault	Phase	Current Magnitude	Voltage Magnitude	Current Magnitude	Voltage Magnitude
Single Line Fault	A	222.4294	2.6522	123.9437	1.4397
	B	222.8659	2.5907	121.8612	1.5078
	C	223.2474	2.5285	119.7486	1.5755
Double Line-Ground Fault	AB-G	223.5739	2.4656	117.6065	1.6429
	AC-G	223.8452	2.4022	115.4354	1.7098
	BC-G	224.0612	2.3381	113.2357	1.7763
Line to Line Fault	AB	224.2220	2.2735	111.0082	1.8424
	AC	224.3275	2.2083	108.7532	1.9080
	BC	224.3775	2.1426	106.4715	1.9732
3 Phase Balance Fault	ABC-G	224.3723	2.0763	104.1634	2.0379

From the results, it is evident that the current magnitude for each fault type at the instant of occurrence is higher than its corresponding voltage magnitude. This also explains the fact that when fault takes place in a power system network, current and voltage values deviate from their nominal values. The faults in power system cause over current and under voltage. Hence, reason for high current magnitudes

against voltage magnitudes at both ends of the transmission line.

IX. CONCLUSION

This paper deals on the behaviour of the transmission line voltages and currents when fault does occur. Modelling and Simulations were carried out using Simscape Power Systems tools box available in Simulink to demonstrate the behaviour of the network during transient conditions and the current and voltage waveforms were measured. The waveforms depict behaviours of transmission line during fault.

REFERENCES

- [1] Avagaddi Prasad, J. Belwin Edward and K. Ravi (2017). "A review On fault Classification Methodologies In Power Transmission Systems", Journal of Electrical Systems and Information Technology.
- [2] Isa. S. Qamber, Sayed Ali Hassan, Taha Juma Ali, Maitham Farahat, Hussain A. Nabi (1998). "Oherhead Transmission Line Modelling Study", Journal of Scientific and Engineering Research.
- [3] Mohammad Abdul Baseer, (2013) "Travelling Waves For Finding The Fault Location In Transmission Lines", Journal of Electrical and Electronic Engineering
- [4] R. S. Meena and M. K. Lodha (2015), "Unsymmetrical Fault Analysis & Protection of the Existing Power System" , International Journal of Multidisciplinary Research and Modern Education (IJMRME).