

Android Based Smart Automation System Using Multiple Authentications

S. K. Saravanan¹, M. Asan Nainar², V. Santhana Marichamy³

^{1, 2, 3} Assistant Professor [Selection Grade], Department of General Engineering, SRM Valliammai Engineering College, Chennai, Tamil Nadu, India

Abstract -- Smart Home is the term commonly used to define a residence that uses a home controller to integrate the residence's various home automation systems. The most popular home controllers are those that are connected to a Windows based PC. In our research we presented a part of smart home technology which using Bluetooth in a mobile device, so it will more easy and efficient to use. It also based on Android and Arduino platform both of which are free open source software. In this paper, a system called door locks automation system using Bluetooth-based Android Smartphone is proposed and prototyped. First the hardware design and software development are described, then the design of a Bluetooth-based Smartphone application for lock/unlock the door are presented. The hardware design for door-lock system is the combination of android smart phone as the task master, Bluetooth module as command agent, Arduino microcontroller as controller center / data processing center, and solenoid as door lock output. All of the tests indicate that all goes according to the initial design of this research.

Indexed Terms -- Android, Arduino Uno, Door Automation, Bluetooth, Smart phone

I. INTRODUCTION

Automation is a technique, method, or system of operating or controlling a process by electronic devices with reducing human involvement to a minimum. The fundamental of building an automation system for an office or home is increasing day-by-day with numerous benefits. Industrialist and researchers are working to build efficient and affordability automatic systems to monitor and control different machines like lights, fans, AC based on the requirement. Automation makes not only an efficient but also an economical use of the electricity and water and reduces much of the wastage. Automation is another important application of wireless technologies like Bluetooth. It is the monitoring of the energy consumption and the Controlling the environment in buildings, schools, offices and museums by using different types of sensors that control lights, temperature. To make it

more operative and efficient, cost is reduced by low cost communication technology like Bluetooth.

Bluetooth is nice technology to use in home automation [2]. This technology allows to the users instantaneous connections of voice and information between several devices in real time. The way of transmission used assures protection against interferences and safety in the sending of information in arrange up to 100 meters. Building upon this theme; we propose a home automation system based on Bluetooth technology available in Android smartphones.

The use of Bluetooth technology in a smart phone today is not just for the transfer of data and files only. In recent years, smart home automation is one of the applications of Bluetooth technology. Bluetooth technology operate over unlicensed, its available at 2.4GHz frequency, it also can link digital devices within a range of 10m to 100m at the speed of up to 3Mbps but it depending on the Bluetooth device class [5]. With these qualifications of Bluetooth; we offer a door automation system based on Bluetooth technology, especially in doorautomation system.

II. LITERATURE REVIEW

As per review, now a day there are various systems exists but they are hard to handle, maintain and use. N. Sriskanthan, F. Tan, A. Karande [4] presented model for home automation using Bluetooth via PC. This application of Bluetooth technology in home automation and networking environment. They proposes a network, which contains a remote, mobile host controller and several client modules (home appliances). The client modules communicate with the host controller through Bluetooth devices. The researchers even built a new protocol on top of the Bluetooth software stack, called Home Automation Protocol (HAP), to make the communication between devices possible. The device controller is connected to electronic devices through the I2C Bus. The system allows more than one device controller to be

connected to the host controller. But unfortunately the system lacks to support mobile technology.

Deepali recommends the use of the android platform version 2.3.4 Gingerbread and 3.1 Honeycomb using the Java programming language for smart home security system for the disabled and senior citizens [7]. In his research , the connection between android platform and the home device using wired conection, so It will be more efficient to support various wired as well as wireless technologies such as Bluetooth, Zigbee, Wi-Fi, World Wide Web. The implementation of Bluetooth for home security systems using the ARM9 processor were introduced by Naresh [8]. Hao Shi, in his research on home lighting settings implemented an open-source Android Development Tools (ADT), the Android SDK (Software Development Kit) and Java Development Kit (JDK) [9]. ManaseePatil had examined home automation system using RFID, Wireless Sensor Network (ZigBee) technology and GSM. ZigBee is low power wireless technology used for monitoring and controlling various devices [10]. R. Piyare [11] has introduced design and implementation of a low cost, flexible and wireless solution for home automation, especially on on/off the lamp and to on/off the television automatically. However, this is a basic system without advanced features like integration of RTOS, and also not has light sensors that are used to intelligently control the home appliances without human intervention.

All research that mention above, inspired our research to make a research about the device that providing a safe and efficient solution for controlling home automation. The first step to build a smart home is about the security and the door is the mayor device for security system.

The device is a system to lock and unlock the door. Rather than using a key, it uses a command that is delivered digitally via Bluetooth on Smartphone and other mobile devices. The use of electronic lock using Bluetooth on Android smart phones in addition to providing ease of use, also provide better security than conventional key.

The system designed to simulate an electronic key, which is controlled through a Bluetooth-enabled smart phone. Controlling conducted by sending a command via Bluetooth to the Arduino circuit that acts as a connection between Android smart phone and solenoid.

Solenoid door lock is the electronic device that made for door lock and often use for automatic door locks.

Solenoid will operate if the system has a voltage. The average of the solenoid door lock is 12 volt. In normal condition, the lever will be Normally Closed. If there is any voltage through the solenoid, it will unlock the door. Usually the solenoids combine with electric key lock system with RFID and password. In our research we combine solenoid door lock with Bluetooth-based smart phone.

III. SYSTEM DESIGN

This work is more favored on speech command method. User can use speech command to control the system. When the micro phone button is touched, it will call google voice to text function. Then a special window from google will appear to the android screen. In that time user can say the command to the phone. The microphone icon of google voice to text will flash, showing that it tries to detect the spoken word. It will change from voice to text. Detected word will print on the android screen in the text formed, so the user will print on the android screen in the text formed, so the user will know if it is the correct command or not.

The detected text in the android application directly sends to the micro controller via Bluetooth. The text will be received by micro controller and directly check if it is proper command or not. The automation system will run as its function when the micro controller designated it as a proper command. Figure 1 below shows the speech command system design of door automation system design.

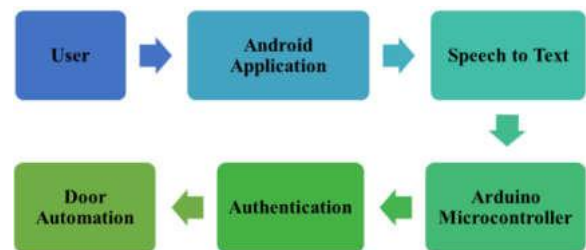

Figure 1. Speech Command System Design

The distributed proposed work of home automation system in automate the door consists of two main components, the hardware interface based home automation system and its software control components.

IV. HARDWARE ARCHITECTURE AND IMPLEMENTATION

There are several step in hardware design, i.e.

- The design of Arduino Uno circuit
- The design of Bluetooth circuit

- The design of Solenoid door lock circuit
- The design of LED circuit
- The design of power supply circuit
- The design of driver relay circuit

Arduino microcontroller serves as the brain of the whole series. [12] The microcontroller can be linked with other circuits to perform certain functions. The Arduino microcontroller using IC ATmega328P-PU and works by entering the program that has been created and ready for instantly use.

Bluetooth module used in this circuit is the type of HC-05, which requires a 3.3 V DC power drawn from the Arduino microcontroller circuit (pin 3.3 V), Pin (TX 1) is a pathway transmit / send data on the Bluetooth module HC-05 with microcontroller and Pin (Rx 0) as the receive path / receiver data on the HC-05 Bluetooth module with microcontroller while the path GND (Ground) is a path connecting the data between HC-05 Bluetooth module with microcontroller circuit.

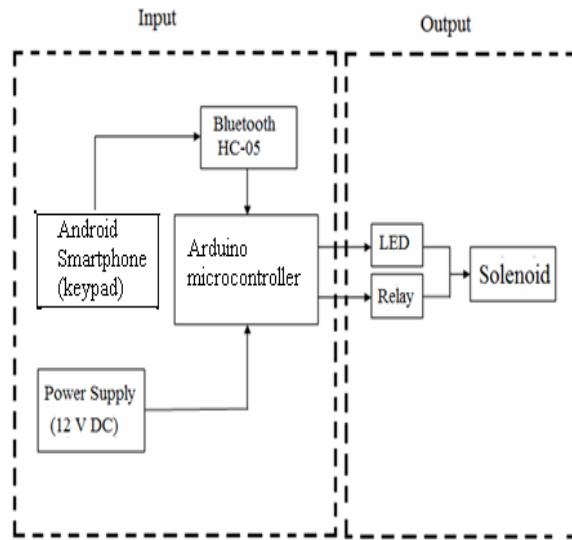

Figure-2. Block diagram of door automation system using android.

The block diagram in Figure-2 describes the system overall. This system has input from android Smartphone using Andruino software (v0.11), the overall system is controlled automatically and the output is a solenoid that connected to the Arduino microcontroller circuit.

V. IMPLEMENTATION

Our Home automation system uses an Android based Bluetooth enabled phone for its application and the Arduino Uno as the microcontroller. The key components of this system are:

- 1) Arduino Uno
- 2) Bluetooth module
- 3) Android based phone

i) **Arduino Uno** The Arduino Uno is a microcontroller board based on the ATmega328p [9]. It is simple, inexpensive, open source prototyping platform extensible to hardware and software. It has 14 digital input/output pins (of which 6 can be used as PWM outputs), 6 analog inputs, a 16 MHz ceramic resonator, a USB connection, a power jack, and a reset button. It contains everything needed to support the microcontroller. We either need to connect it to a computer using a USB cable or power it with an AC-to-DC adapter. The Arduino circuit acts as an interface between the software part and the hardware part of the project.

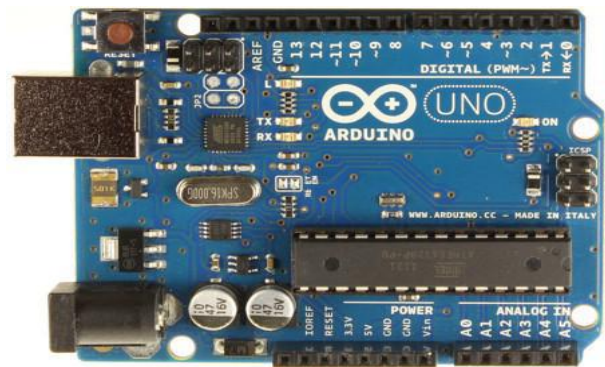

Figure 3: Arduino Uno Board

ii) **Bluetooth Module** Bluetooth is a wireless technology standard for exchanging data over short distances [11] (using short-wavelength UHF radio waves in the ISM band from 2.4 to 2.485 GHz) from fixed and mobile devices, and building personal area networks (PANs). The Bluetooth module being used allows us to transmit and receive signals. It receives the text from the Android phone and transmits it to the serial port of the Arduino Uno. The Bluetooth module being used here is the HC-05 module, shown in fig. 2. It is an easy to use Bluetooth SPP (Serial Port Protocol) module, designed for transparent wireless serial connection setup. The Bluetooth module HC-05 is a master/slave module [12]. By default the factory setting is slave. The Role of the module (Master or Slave) can be configured only by at commands. The slave modules cannot initiate a connection to another Bluetooth device, but can accept connections. Master module can initiate a connection to other devices.



Figure 4: Bluetooth HC-05 Module

iii) **Android based phone** Android is software stack for mobile devices that includes an O.S, middleware and key applications. Android O.S is based on Linux and applications are made in java [10] like a language running on virtual machine called „Dalvik“ created by Google [1]. For this automation system and security we are using open source android platform. Our Android application consisting of controlling device list as lights, fans according to rooms. First user has to start application, for safety purpose username and password is given for authorized user. If user is authorized he will be asked for making Bluetooth ON. After that he will be having list of available devices in range for serial connection. Once he connects to HC-05 he will be navigated to main screen which is consisting of list of devices of that he wants to control as make it on or off, display current temperature, set time for auto off devices at night time.

As our system is based on Bluetooth technology, as shown in fig.5, system involves wireless connection into Smartphone and Bluetooth module HC-05. Bluetooth Module and all appliances are connected with Arduino Uno Board directly with help of wires and breadboard. This system works on client-server model, here Bluetooth in Smartphone is act as server while HC-05 acts as client.

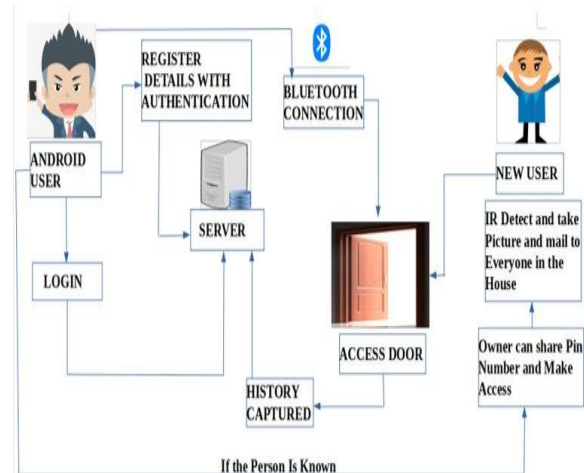

Figure 5: Block diagram of smart automation system using Bluetooth

Graphics User Interface(GUI)

In order to monitor and control household appliances, android application has to start clicking on its icon in smartphone. Enter username and password, to enter into application and turn Bluetooth ON, as shown in fig.5. Then paired device list has appeared and select serial Bluetooth device i.e.HC-05. All lights, fan, temperature, auto off button and door security buttons has appeared on screen. To control them, choose ON/OFF or LOW/HIGH buttons. Smartphone then sends its command to appliances through Bluetooth communication via Arduino Uno board.

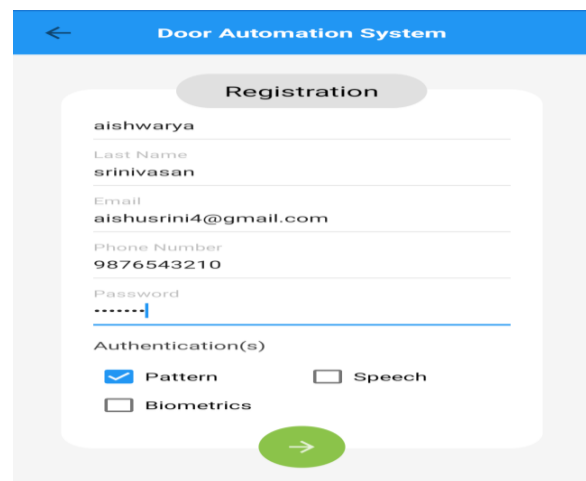

Figure 6 Registration Page

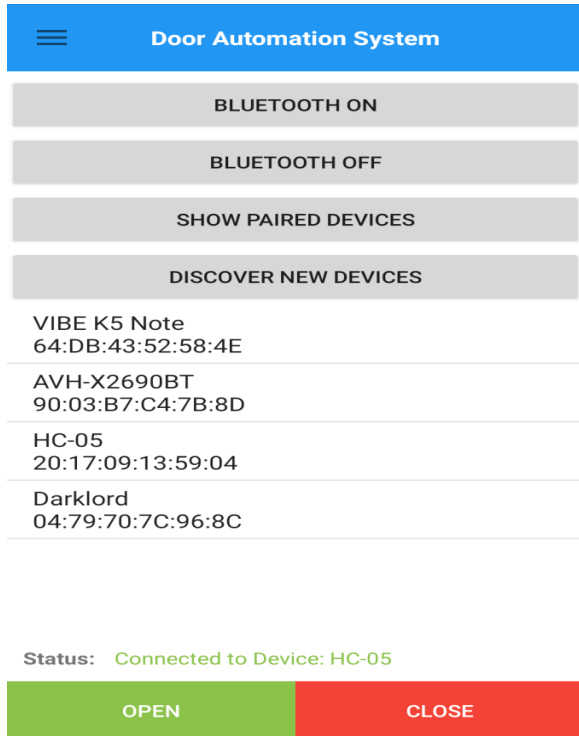

Figure 7 Connecting Blue Tooth

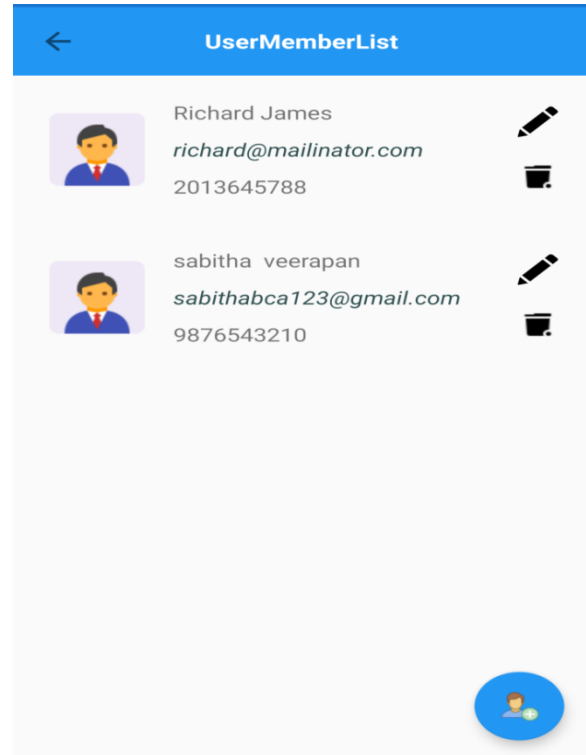

Figure 9 Guest Accessing by Password

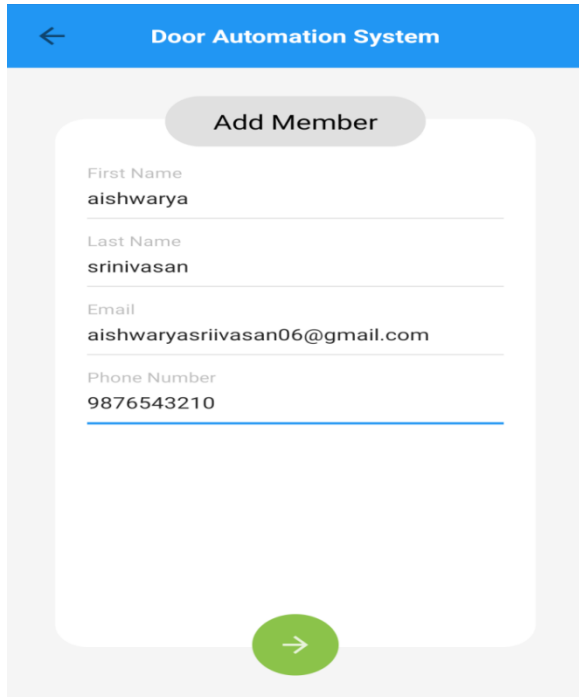

Figure 8 Add Member

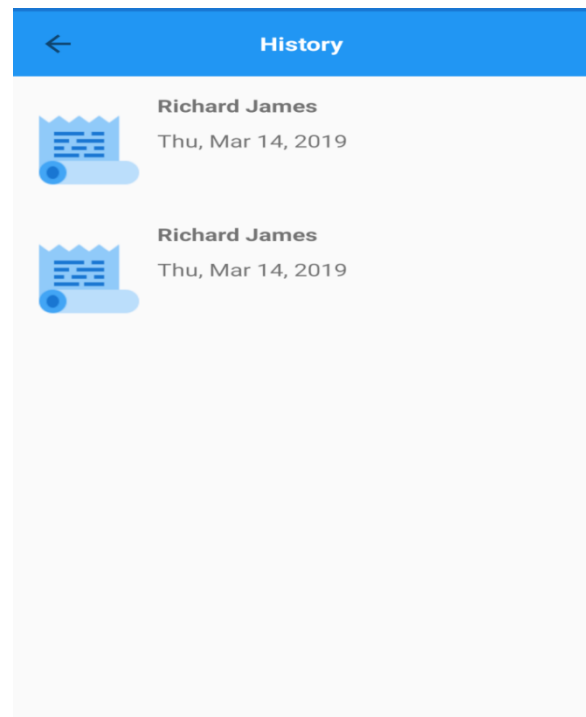

Figure 10 View the History



Figure 11 Detect Human

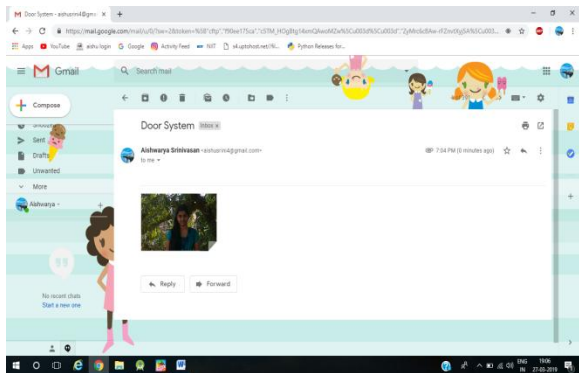

Figure 12 Image Captured and send to mail



Figure 13 Enter the PIN and Door Open

VI. CONCLUSION

Our paper has an objective to develop smart home automation with help of Arduino and Bluetooth wireless technology. Our wish to develop such an application is not only for common man and it will be boon for elderly and disabled. System allow user to monitor and control household appliances like lights, fan. It involves auto off lights at night by setting time. We can also able to see current temperature. It secures home by alerting people when smoke detected or gas is leaked. In terms of security, doors and windows are secured by setting alarm in case of any kind of thief movement. Our project is feasible because the cost is very less as compared to other systems and easy to handle, freely available.

VII. FUTURE WORK

Looking at current task, limitation to control only some devices can be removed by extending it to all other appliances. More security will be provided to home using security cameras, motion sensors for notifying authorized user. For door and window,

Glass braking sensor can be used by setting more security. In smoke condition, will call owner to alert them and call fire department.

REFERENCES

- [1] Deepali Javale, Mhd. Mohsin, Shreerang Nandanwar, Mayur Shingate, "Home Automation and Security System Using Android ADK", International journal of Electronics and Computer Technology, Vol 3, Issue 2(March 2013).
- [2] Sudhir Kumar, Monica Deswal, "Smart Home System", 2013 International conference on Advances in Computing and Communication.
- [3] R. Piyare, M. Tazil" Bluetooth Based Home Automation System Using Cell Phone", 2011 IEEE 15th International Symposium on Consumer Electronics.
- [4] N. Sriskanthan and Tan, Karande. "Bluetooth Based Home Automation System". *Journal of Microprocessors and Microsystems*, Vol. 26, pp.281- 289, 2002.
- [5] Al-Ali, Member, IEEE & M. AL-Rousan, "Java-Based Home Automation System R." IEEE Transactions on Consumer Electronics, Vol. 50, No. 2, MAY 2004.
- [6] Muhammad Izhar Ramli, Mohd Helmy Abd Wahab, Nabihah, "TOWARDS SMART HOME: CONTROL ELECTRICAL DEVICES ONLINE", Nornabihah Ahmad International Conference on Science and Technology: Application in Industry and Education (2006).
- [7] E. Yavuz, B. Hasan, I. Serkan and K. Duygu. "Safe and Secure PIC Based Remote Control Application for Intelligent Home". *International Journal of Computer Science and Network Security*, Vol. 7, No. 5, May 2007.
- [8] H. Kanma, N. Wakabayashi, R. Kanazawa, H. Ito, "Home Appliance Control System over Bluetooth with a Cellular Phone," IEEE Transactions on Consumer Electronics, vol. 49, no. 4, pp.1049-1053, Nov. 2003.

- [9] M. Patil and S.R.N. Reddy. 2013. Comparative Analysis of RFID and Wireless Home/Office Automation. International Journal of Soft Computing and Engineering (IJSCE). 3: 151-154.
- [10] 2014. How Bluetooth Technology Works, [online]. Available: www.bluetooth.com/bluetooth/technology/works.
- [11] Diao, M F, Mahmood, B M, Data Acquisition of Greenhouse Using Arduino, Journal of Babylon University/Pure and Applied Sciences/ No.(7)/ Vol.(22), 1908-1916, 2014.
- [12] Anandan, R, Karthik, B, Kumar, K, WIRELESS HOME AND INDUSTRIAL AUTOMATION SECURITY SYSTEM USING GSM, JGRCS, Volume 4, No. 4, 126-132, 2013.
- [13] Asif, O, Hossain, B, Hasan M, Rahman, T, Chowdhury, M, Fire-Detectors Review and Design of an Automated, Quick Responsive Fire-Alarm, 2014.
- [14] Violino, B, The 'Internet of things' will mean really, really big data, InfoWorld, 2013. <http://www.infoworld.com/article/2611319/computer-hardware/the--internet-of-things--will-mean-really--really-big-data.html>
- [15] 2013. Arduino ICSP programming header pinout [online], available: <http://www.enchantedage.com/node/244>.
- [16] 2014. Arduino Home Page [online], available:
- [17] <http://arduino.cc/en/Main/arduinoBoardUno>.