

# Economic Load Dispatch for Modified Extended Generator Fuel Cost Function with Valve Point Loading

EZEABASILI CHIBUIKE P.<sup>1</sup>, ANIONOVO UGOCHUKWU E.<sup>2</sup>, EMMANUEL A. ANAZIA<sup>3</sup>

<sup>1, 2, 3</sup> Department of Electrical Engineering, NamdiAzikiwe University Awka, Anambra State, Nigeria

*Abstract- Modern power systems around the world have expanded on capacity of interconnection and power demand. In this change of perspective, scarcity of energy resources, increasing power generation cost and environmental concerns call for load dispatching. Economic load dispatch determines the unit output allocation of power plant at minimum cost. Quadratic models of generator fuel cost functions are the most approximation without valve point loading effect which in turns, alters the convex plot of cost against generator output with periodic sinusoidal ripples. This research article focuses on formulation of quadratic equivalent of the fuel cost with valve point loading effect and conducting economic load dispatch of the network modified cost function. MATLAB programming tool was utilized to build the code used to generate the cost of fuel by executing the functions given data inputs in the test 26 network buses under consideration. Simulated results have been provided to demonstrate the network's behavior at various points of loading. The regression plots of the various generator output cost were presented and from the test results, it shows the NON-CONVEX periodic curves for output cost with valve point loading effect is absent when the system function is modified.*

*Indexed Terms- Economic Load Dispatch, Valve Point Loading, Modified Cost Function, Quadratic Cost function.*

## I. INTRODUCTION

The interconnection of electrical components such as generators through the transmission lines have been designed to ensure reliable supply to the entire system load. While most plants have net reserve capacity, the interconnection guarantees that each generator within the network enjoys extended reserve capacity such that every load can be reliably supplied from distance generators via alternative transmission routes. The

operation of a power system as well as with the planning stage, the AC load flow analysis is essential in order to estimate nodal voltages and their corresponding phase angles, active and reactive power schedules. The information obtained are instructive in evaluating transmission line flows and are fundamental requirement for further power system analysis like fault analysis, contingency analysis, design and installation of protective schemes. In order words, load flow analysis enables the evaluation of flows on account of the system configuration, load demand and generator capabilities. During load flow, violation of operational limits may exist but may proceed till convergence and intentional effort is made to mitigate constraint or component limits. In practice, power plants are geographical distance from each other and the load centers with different generation costs. At all loads and generator buses, these power schedules are held constant except at the slack or reference bus where it varies within a limit for a given system load. If all generators were to be allowed to vary their output, then they would be numerous possible combinations and from an economic point of view, only one of these combinations would result in the most economic total system generation cost. The route to estimating generator outputs whose cost when summed yield the minimum total cost is an Economic Loading Dispatch problem (ELD). ELD problem has two aspects. The unit commitment or re-dispatch is the first aspect that involves the choice of which generating units among all available units within a station to meet the system load demand and resultant losses and provide an adequate margin of system reserve over a significant operational period. The second aspect is the on-line distribution of the load among committed units in order to minimize the total generation cost of the system.

II. LITERATURE REVIEW

Economic operation of electric systems is achieved by meeting system load demand through optimal scheduling of real power generation which are the control variables of the fuel cost problem that is to be minimized [1].

The chief objective of ELD is optimal scheduling of unit committed generators for real power generation in order to match system losses plus load while satisfying related operational constraints [2]. From design and operation, electric utility systems are connected so as to achieve the benefits of minimum production cost, maximum reliability and better operating conditions [3]. Some of the methods of optimization used for the economic dispatch problem have considered the cost characteristic to be linear in nature in order to simplify the mathematical formulation of the problem and allow the use of many non-convexional/ traditional optimization techniques. In reality however, the input output characteristic of the generating units are non-linear due to the valve point loading effect and therefore more advance methods are employed to solve the dispatch problem [4]. [5] Proposed a new method for dealing with economic load dispatch problem with valve point effects. The new approach known as modified differential evolution (MDE) algorithm was geared towards improving the differential evolution algorithm by taking into account the scaling factor, selection scheme, auxiliary set, and treatment of constraints. [6] Carried out a review work on economic dispatch using particle swarm optimization (PSO). The study summarized the previous work done on the use of PSO for economic dispatch and compared the performance of PSO with conventional optimization techniques. [7] presented a novel method for economic dispatch with across neighbourhood search (ANS) for a provincial power grid in China. The ANS is population based algorithm such that a population size collaboratively navigate through the search space in order to obtain the optimal solution by performing simultaneous search of the neighbourhoods of multiple superior solutions. [8] Studied the effect of valve point loading on the thermal power economic load dispatch using new elephant herding optimization (EHO). It proposed EHO and modified EHO (MEHO) for the optimization of linear as well nonlinear cost function.

The power plant have multiple steam valves, so that a complete analysis requires the consideration of valve point loading effect which produces a more accurate solution to the minimization problem. Valve-point loading affects the input-output characteristics of generating units making the fuel cost nonlinear and non-smooth.

III. ECONOMIC LOAD DISPATCH MODELS

a) Without Valve Point Loading

For all intent and purpose, the fuel cost,  $F_i(P_i)$  of generator  $i$  can be represented as a quadratic function of real power generation.

$$F_i(P_i) = a_i + b_i P_i + c_i P_i^2 \tag{1}$$

Now for a network with  $n_g$  being the number of committed generating units/plants, with each plant fuel cost function  $F_i(P_i)$  known, the objective of ELD is to find the real power generation for each plant such that the objective function as defined below is minimum subject to the above constraints.

$$F_C = \sum_{i=1}^{n_g} F_i(P_i) \tag{2}$$

$$F_C = \sum_{i=1}^{n_g} (a_i + b_i P_i + c_i P_i^2) \tag{3}$$

Where

- $F_C$ : Total Fuel Cost given in (currency unit/hr),
- $F_i(P_i)$ : (currency unit/hr), Fuel Cost of Plant/Generator Unit  $i$
- $P_i$ : (MW), the real power generation of Plant/Generator Unit  $i$
- $a_i$ ;  $b_i$  And  $c_i$ : Cost coefficients of Plant/ Generator Unit  $i$  and have the respective units of (currency unit/hr), (currency unit/MW hr) and (currency unit/MW<sup>2</sup> hr),
- $n_g$ : Number of plants/generating units

b) With Valve point loading

The fuel cost of thermal units due to valve point loading is presented with modification to the ordinary fuel cost by the introduction of a sine term as

$$F_{i,VPL}(P_i) = a_i + b_i P_i + c_i P_i^2 + |e_i \sin(d_i(P_i^{\min} - P_i))| \tag{4}$$

$$F_{C,VPL} = \sum_{i=1}^{n_g} F_{i,VPL}(P_i) \tag{5}$$

$$F_{C,VPL} = \sum_{i=1}^{n_g} (a_i + b_i P_i + c_i P_i^2 + |e_i \sin(d_i(P_i^{\min} - P_i))|) \tag{6}$$

Where,  $F_{i,VPL}(P_i)$ : Fuel cost with Valve Point Loading effect of Plant/ Generator Unit  $i$ ,  $F_{C,VPL}$ : Total Fuel Cost with valve point loading,  $e_i$  and  $d_i$ : Valve point loading effect cost coefficients of Plant/Generator Unit  $i$

The resultant modified Extended Generator Fuel Cost functions are state in equations (7) and (8).

$$F_{i,VPL}(P_i) = a_i + b_i P_i + c_i P_i^2 + a_{i,vpl} + b_{i,vpl} P_i + c_{i,vpl} P_i^2 \quad (7)$$

$$F_{i,VPL}(P_i) = a_i' + b_i' P_i + c_i' P_i^2 \quad (8)$$

The coordination equation reflecting the objective cost function, constraints and incremental fuel cost is stated in equation (9) and (10)

$$F'_{total} = \sum_{i=1}^{ng} F'_i \quad (9)$$

Constraints:

Equality:  $\sum_{i=1}^{ng} P_i = P_d + P_L$

Inequality:  $P_i^{min} \leq P_i \leq P_i^{max}$

Coordination Equation:

$$P_i = \frac{\lambda - b_i'}{2c_i'} \quad (10)$$

Expression for Transmission Line Flow from bus  $i$  to bus  $k$ :

$$S_{ik} = V_i(V_i^* - V_k^*)y_{ik}^* \quad (11)$$

IV. MATERIALS AND METHODS

The material used for this analysis is Matlab and method involved mat file programming and

Gen Name	Cost Coefficient			VPL Cost Coefficient		Modified cost Coefficient with VPL effect			Generator Unit Limits	
	$a_i$	$b_i$	$c_i$	$e_i$	$f_i$	$a_i'$	$b_i'$	$c_i'$	$P_i^{min}$	$P_i^{max}$
Gen1	240	7	0.007	290	0.0567	268.6516	7.2856	0.007	100	500
Gen2	200	10	0.095	240	0.095	219.874	10.3966	0.095	50	200
Gen3	220	8.5	0.009	265	0.0758	247.944	8.8486	0.009	80	300
Gen4	200	11	0.009	190	0.0812	213.4522	11.2686	0.009	50	150
Gen5	220	10.5	0.008	200	0.0694	232.1052	10.7418	0.008	50	200
Gen26	190	12	0.0075	165	0.0572	198.2328	12.1645	0.0075	50	120

A plot of the cost function between their output limits,  $P_i^{min} \leq P_i \leq P_i^{max}$ . The resulting graphs for each generator are presented below numbered Figure 2 – 7.

simulation. The existing model and developed model based on valve point loading effect were each coded in Matlab programming tool and simulated with raw data obtained from the utility company for the purpose of comparison.

V. RESULTS AND ANALYSIS

A test network containing 26 buses; 6 generators one each at bus numbers 1, 2, 3, 4, 5 and 26 with bus 1 chosen as the network Slack bus and the other 20 buses as load buses. Transformers are attached between bus 2 & 3, 2 & 13, 3 & 13, 4 & 8, 5 & 19 and 7 & 9, 7 transformers within the 46 transmission lines of the network. Bus numbers 1, 4, 5, 6, 9, 11, 12, 15 and 19 have Shunt Capacitors attached to them. The details of generation cost coefficients, generation limits; are shown in table 1.

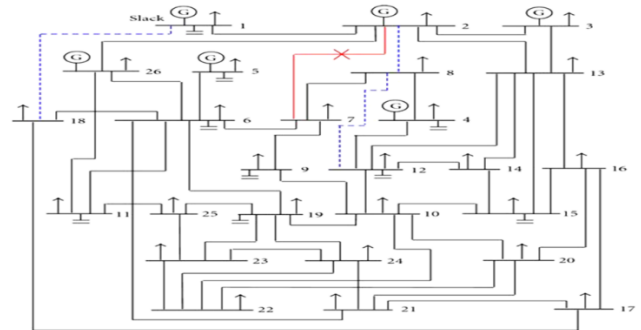

Fig. 1: Test 26 Bus 6 Generator Model

Table 1 Generator data with Cost Coefficients for the generating units of the 26 bus Network

Each generator unit has three subplots numbered a – c. The first graph (a), is a plot of the ordinary cost function and the cost with valve point loading effect.

The second graph (b) represents the plot of the cost function with valve point loading and its modified equivalent cost function. The third (c) is a composite involving all three cost functions. Notice the non-smooth, non-convex periodic curves for costs with valve point loading effect which is absent when modified. The modified cost functions resemble the ordinary cost function but with higher cost values per generator output. The tables of values for these plots are presented in Tables 2 - 7.

In the plot of figures numbered (a), the ordinary cost function produces a linear blue colored line as expected within the limit of the generator output while the non-smooth periodic curve is a result of the sine term in the extended cost function with valve point loading effect. As seen from each generator's table of values and figure numbered (a), for any output the corresponding costs for the ordinary cost function is less than the equivalent cost for the extended cost function and this is as expected.

Again all the figures numbered (b) show the combined plots of the extended cost function and its modified counterpart. While the sine term produces the periodic non-smooth concave curve, the modified function which is a quadratic expression similar to the ordinary cost function produces a linear line within the range of values. In the modified curve, some output points have a cost higher than their corresponding cost in the extended cost function. All points on the modified curve have a positive slope unlike the extended curve where certain ranges of values have negative slopes. The combined plot of figure numbered (c) as well as their table of values shows that the corresponding costs for all real power output are higher in the modified cost function than in the ordinary cost function.

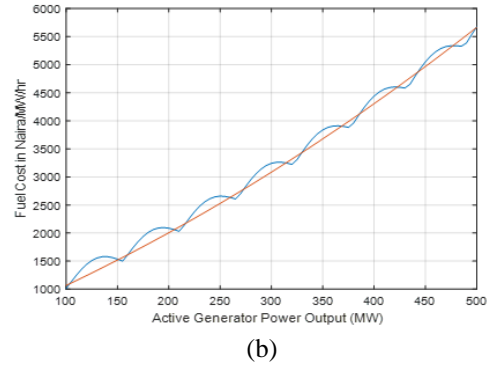
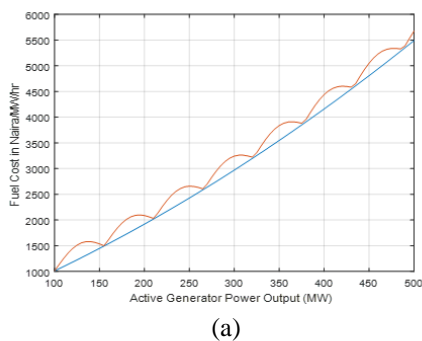

Figure 2: Plot of Cost-Output characteristic for generator at bus 1 (Gen1)

(a): Ordinary cost function and unmodified cost function with valve point loading

(b): Modified cost function and unmodified cost function each with valve point loading

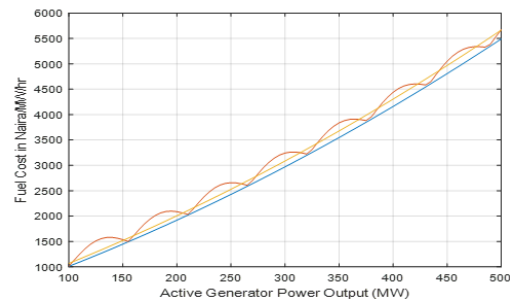

Figure 2 (c): Composite plot of the three cost functions for generator unit 1

Table 2: Output and Cost values for generation unit 1

Unit Output	Ordinary Cost Function ( $C_i$ )	Unmodified Cost Function with VPL ( $F_i$ )	Modified Cost function with VPL ( $F'_i$ )
100	1010	1010	1067.3
120	1180.8	1443.6	1243.9
140	1357.2	1579.5	1426.1
160	1539.2	1613.9	1613.9
180	1726.8	2012.3	1807.3
200	1920	2086.9	2006.3
220	2118.8	2263.1	2211
240	2323.2	2612.2	2421.2
260	2533.2	2633.4	2637.1

280	2748.8	2953	2858.5
300	2970	3243	3085.6
320	3196.8	3223.5	3318.3
340	3429.2	3679.5	3556.6
360	3667.2	3905.8	3800.5
380	3910.8	3959.3	4050
400	4160	4439.6	4305.1
420	4414.8	4602.9	4565.9
440	4675.2	4795.7	4832.2
460	4941.2	5231.2	5104.2
480	5212.8	5337.7	5381.8
500	5490	5674.3	5664.9

Table 3: Output and Cost values for generation unit 2

Unit Output	Ordinary Cost Function (C <sub>i</sub> )	Unmodified Cost Function with VPL (F <sub>i</sub> )	Modified Cost function with VPL (F <sub>i</sub> ')
50	937.5	937.5	977.27
60	1142	1337.2	1185.8
70	1365.5	1592.6	1413.3
80	1608	1677	1659.8
90	1869.5	2016.3	1925.3
100	2150	2389.8	2209.8
110	2449.5	2581.7	2513.3
120	2768	2854.1	2835.9
130	3105.5	3337.8	3177.4
140	3462	3646.2	3537.9
150	3837.5	3855.5	3917.5
160	4232	4437.2	4316
170	4645.5	4866.1	4733.6
180	5078	5129.5	5170.1
190	5529.5	5690.2	5625.7
200	6000	6238.5	6100.3

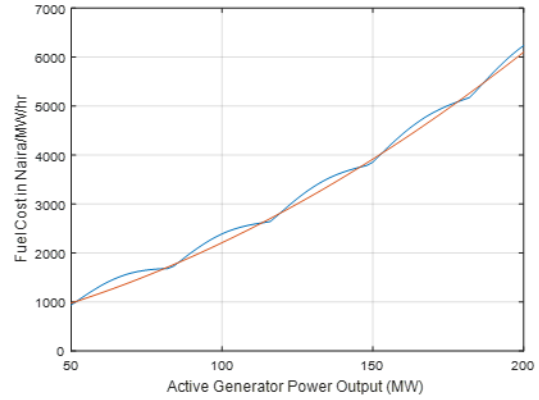

(b)

Figure 3: Plot of Cost-Output characteristic for generator at bus 2 (Gen2)

- a) Ordinary cost function and unmodified cost function with valve point loading
- b) Modified cost function and unmodified cost function each with valve point loading

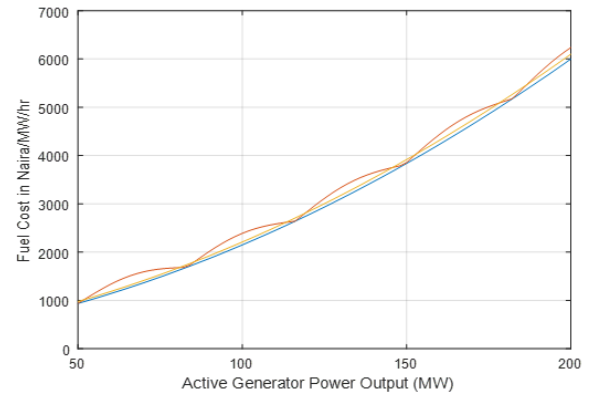
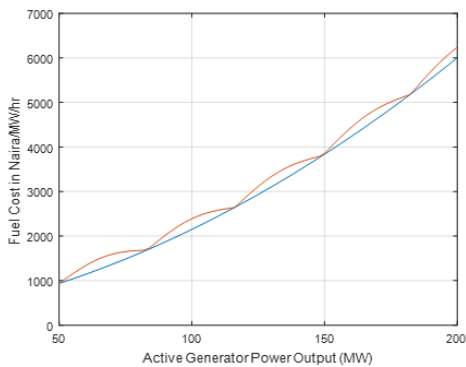
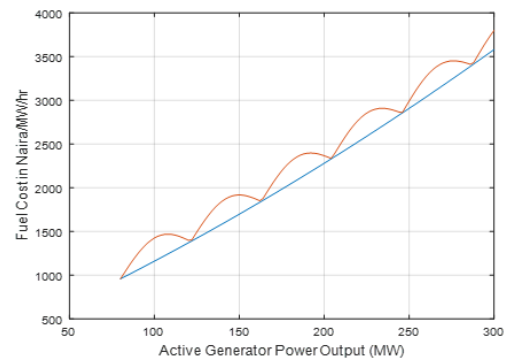

Figure 3 (c): Composite plot of the three cost functions for generating unit 2



(a)



(a)

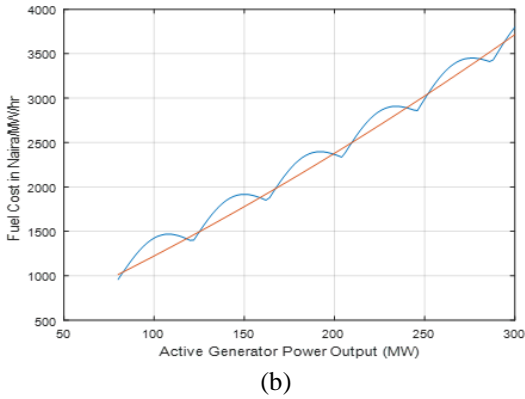

Figure 4: Plot of Cost-Output characteristic for generator at bus 3 (Gen3)

- a) Ordinary cost function and unmodified cost function with valve point loading
- b) Modified cost function and unmodified cost function each with valve point loading

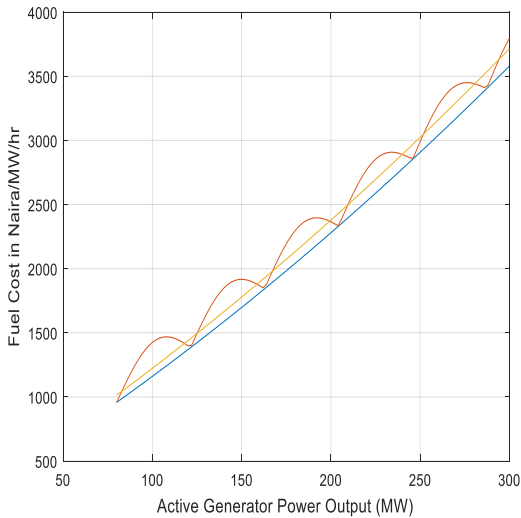

Figure 4 (c): Composite plot of the three cost functions for generating unit 3

Table 4: Output and Cost values for generation unit 3

Unit Output	Ordinary Cost Function ( $C_i$ )	Unmodified Cost Function with VPL ( $F_i$ )	Modified Cost function with VPL ( $F'_i$ )
80	957.6	957.6	1013.6
91	1068	1264.3	1128
102	1180.6	1444.4	1244.4

113	1295.4	1453.7	1363.1
124	1412.4	1463.4	1484
135	1531.5	1758.4	1607
146	1652.8	1906.7	1732.3
157	1776.3	1890.8	1859.7
168	1902	2002.1	1989.3
179	2029.9	2278.8	2121.1
190	2159.9	2394.5	2255
223	2563.1	2824.8	2670
234	2701.8	2908.3	2812.7
245	2842.7	2858.4	2957.6
267	3131.1	3395.9	3253.9
278	3278.6	3449.2	3405.4
289	3428.2	3463.7	3559
300	3580	3798.3	3714.8

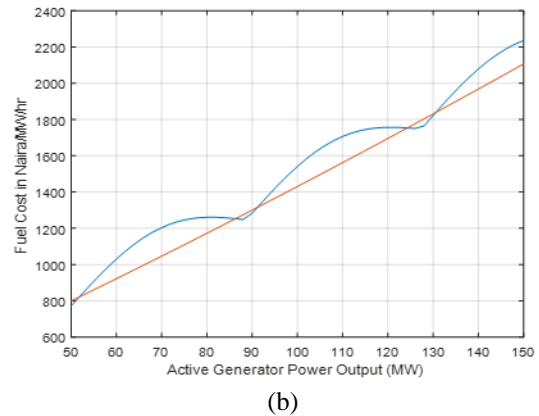
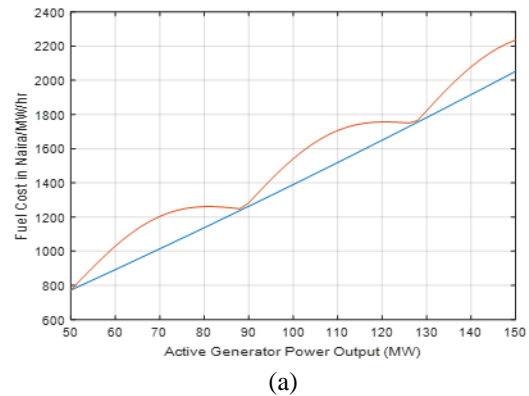

Figure 5: Plot of Cost-Output characteristic for generator at bus 4 (Gen4)

- a) Ordinary cost function and unmodified cost function with valve point loading

b) Modified cost function and unmodified cost function each with valve point loading

Table 5: Output and Cost values for generation unit 4

Unit Output	Ordinary Cost Function ( $C_i$ )	Unmodified Cost Function with VPL ( $F_i$ )	Modified Cost function with VPL ( $F'_i$ )
50	772.5	772.5	799.42
60	892.4	1030.3	922.02
65	953.02	1131.3	983.99
70	1014.1	1203.8	1046.4
75	1075.6	1245.9	1109.3
85	1200	1256.1	1236.4
90	1262.9	1283.1	1300.6
100	1390	1541	1430.4
105	1454.2	1638.5	1496
110	1518.9	1706.5	1562.1
120	1649.6	1756.8	1695.5
125	1715.6	1752.1	1762.9
130	1782.1	1822.2	1830.7
135	1849	1959.2	1899
145	1984.2	2172.4	2036.9
150	2052.5	2235.8	2106.5

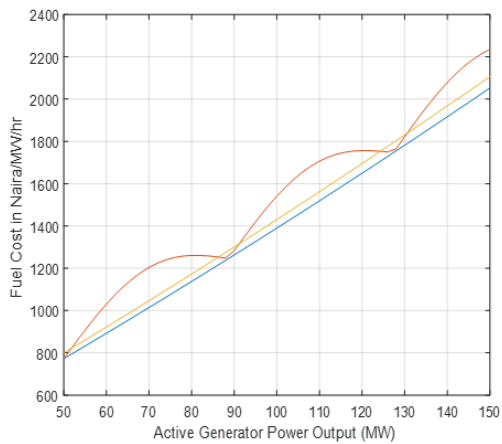
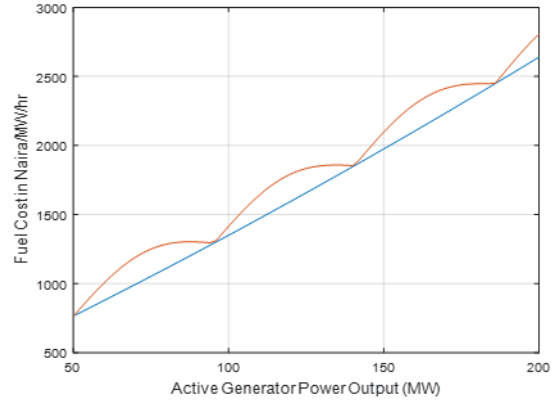
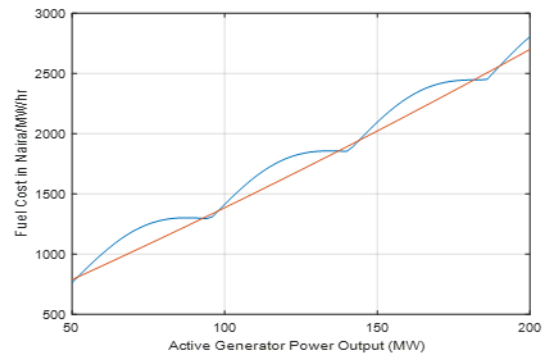

Figure 5 (c): Composite plot of the three cost functions for generating unit 4



(a)



(b)

Figure 6: Plot of Cost-Output characteristic for generator at bus 5 (Gen5)

- a) Ordinary cost function and unmodified cost function with valve point loading
- b) Modified cost function and unmodified cost function each with valve point loading

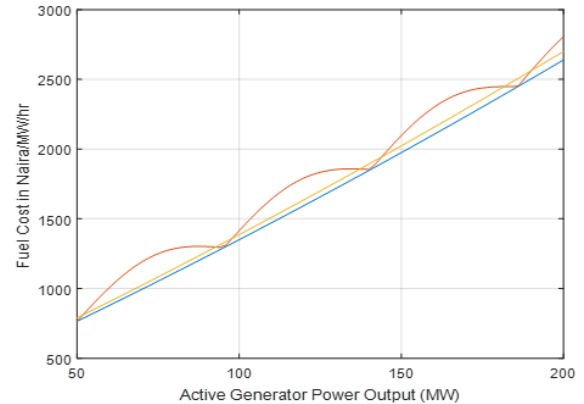
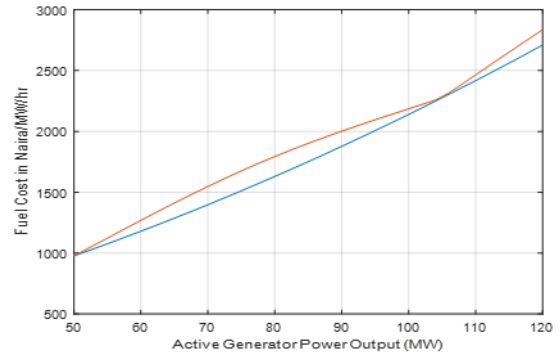

Figure 6 (c): Composite plot of the three cost functions for generating unit 5

Table 6: Output and Cost values for generation unit 5

Unit Output	Ordinary Cost Function ( $C_i$ )	Unmodified Cost Function with VPL ( $F_i$ )	Modified Cost function with VPL ( $F'_i$ )
50	765	765	789.22
60	878.8	1006.7	905.45
70	994.2	1190.9	1023.3
80	1111.2	1285.6	1142.7
90	1229.8	1301.3	1263.7
100	1350	1414.5	1386.4
110	1471.8	1642.5	1510.6
120	1595.2	1793.1	1636.4
130	1720.2	1853.8	1763.9
140	1846.8	1854.2	1892.9
150	1975	2097.1	2023.6
160	2104.8	2300	2155.8
170	2236.2	2414.1	2289.7
180	2369.2	2447.6	2425.1
190	2503.8	2561.2	2562.2
200	2640	2806.7	2700.8

110	2417.5	2464.7	2443.9
114	2532.7	2614.6	2559.7
118	2650.3	2762.5	2678
120	2710	2835.3	2738



(a)

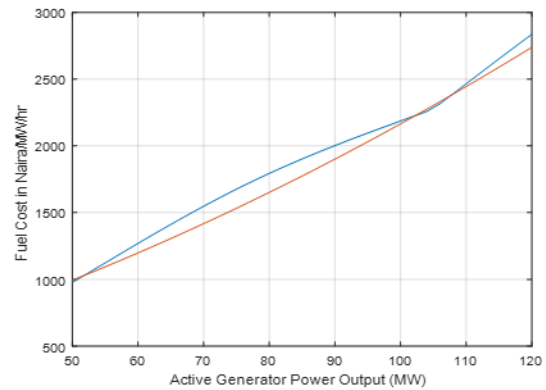

(b)

Table 7: Output and Cost values for generation unit 6 at bus 26

Unit Output	Ordinary Cost Function ( $C_i$ )	Unmodified Cost Function with VPL ( $F_i$ )	Modified Cost function with VPL ( $F'_i$ )
50	977.5	977.5	993.97
54	1056.7	1094.1	1073.8
58	1138.3	1211.2	1156.1
62	1222.3	1326.9	1240.7
66	1308.7	1439.5	1327.8
70	1397.5	1547.7	1417.3
74	1488.7	1650.5	1509.1
78	1582.3	1747.2	1603.4
82	1678.3	1837.8	1700.1
86	1776.7	1922.4	1799.1
90	1877.5	2001.9	1900.6
94	1980.7	2077.2	2004.4
98	2086.3	2149.9	2110.7
102	2194.3	2221.8	2219.4
106	2304.7	2314.9	2330.4

Figure 4.7: Plot of Cost-Output characteristic for generator at bus 26 (Gen26)

- a) Ordinary cost function and unmodified cost function with valve point loading
- b) Modified cost function and unmodified cost function each with valve point loading



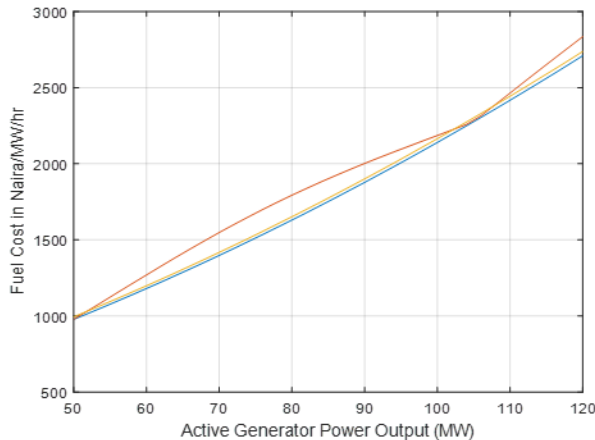

Figure 4.7 (c): Composite plot of the three cost functions for generating unit at bus 26

### CONCLUSION

In order to schedule generators from an economic point of view within their upper and lower output limits, economic dispatch operation is required. This is achieved by expressing the generator operational cost in terms of the generator output and then determining generator outputs that would ensure the minimum cost function in meeting a particular load demand. Optimal load flow analysis is a hybrid analysis involving economic dispatch and load flow analysis. Interestingly, optimal load flow is an extension of load flow taken from an economic point of view that involves the use of generator output from economic dispatch to perform load flow analysis while observing network component and operational constraints. For economic dispatch, the most common ordinary generator cost function is quadratic expressed in terms of the generator output neglecting the effect of valve point loading effect. The ordinary quadratic cost function is an approximate expression obtained on the basis of certain assumptions. A more robust cost function is obtained when a sine term is added to the ordinary cost function which results in an extended cost function. This extended cost function reflects the effect of generator valve point loading of the generators following significant incremental outputs and its presence in the function introduces a non-smooth sinusoidal effect on the otherwise convex cost-output characteristics which makes economic dispatch analysis for a range of load demand complex. However, this work is focused on eliminating this

infused complexity by modifying the extended cost function into an equivalent convex quadratic cost function devoid of the sine term. The result of this modification is a cost function whose value is more exact and whose cost-output plot is without the non-smooth sinusoidal effects.

### RECOMMENDATION

This article recommends that a hybrid technique can be applied for efficient result by taking advantage of the strength of dynamic programming with that of other optimization methods. That is, by appropriately integrating dynamic programming and other optimization technique to solve the problem of economic load dispatch, improved result can be obtained with less time of computation. The developed approach can be tested in other similar networks such as a 30 bus system. Instead of using the thermal generating units of the test 26 bus system, renewable sources of energy such as solar can be used.

### REFERENCES

- [1] Rao D. S. N. M. and Kumar N. (2018). Optimal load dispatch solution of power system using enhanced harmony search algorithm. *European Journal of Electrical Engineering*, 20(4), 469-483.
- [2] Elacqua A. J. and Corey S. L. (1982). Security Constrained Dispatch at the New York Power Pool. *IEEE Transactions on Power Apparatus and Systems*, Vol. PAS-101 (81), 2876-2884.
- [3] Singh N. and Kumar Y. (2013). Economic Load Dispatch with Valve Point Loading Effect and Generator Ramp Rate Limits Constraint using MRPSO. *International Journal of Advanced Research in Computer Engineering & Technology (IJARCET)*, 2(4), 1472-1477.
- [4] Hermamalini S. and Simon S.P. (2010). Dynamic Economic Dispatch with Valve point Effect using Maclaurin Series Based Lagrangian Method. *International Journal of Computer Applications*, 1(17) 45-52.
- [5] Hardiansyah C. (2014). Modified Differential Evolution Algorithm for Economic Load Dispatch Problem with Valve-Point Effects. *International Journal of Advanced Research in Electrical, Electronics and Instrumentation Engineering*, 3(11), 13400-13409.

- [6] Mahor A., Prasad V., Rangnekar S. (2009). Economic dispatch using particle swarm optimization: A review. *Renewable and Sustainable Energy Reviews* 13 2134–2141.
- [7] Xiong G., Zhang J., Yuan X., Shi D., He Y., Yao Y., and Chen G. (2018). A Novel Method for Economic Dispatch with Across Neighborhood Search: A Case Study in a Provincial Power Grid, China. *Hindawi Complexity*, 1-18.
- [8] Singh N. Kumar M. P. and Kumar B. S. (2019). Effect of Valve Loading on the Thermal Power Economic Load Dispatch Using New Elephant Herding Optimization. *International Journal of Recent Technology and Engineering*, 7(6S4), 345-349.