

IoT Based Smart Poultry Farm

RAKHEE PATIL¹, VANDANA. K², MEKALA. ANUSHA³, RAJARAJESHWARI. M⁴, RAMYA. G⁵

¹ Assistant professor, Department of Electronics and Communication Engineering, RYMEC, Bellary, INDIA.

² UG student, Department of Electronics and Communication Engineering, RYMEC, Bellary, INDIA.

Abstract- For easy day to day life enhancement in technology has been developed so widely and in much faster rate. Smart poultry farms can emancipate the farmers from the traditionally tedious procedures which were outdated and time consuming. In preliminary stage, a smart poultry farm shows many distinctive features such as, automated food and water supply, egg collection, maintaining precise environmental factors etc. In this paper, Safety measures such as fire protection, anti-thief features which ensures an overall surveillance of the farm has been incorporated. Data storage through IoT is another enticing trait of this work which enables the users to Fig. out the required presteps to adopt before any endangerments can occur.

I. INTRODUCTION

SSSThe Poultry Culture in India has increased to leaps and bounds in the past few years or decades. The country contributes majorly in the export of the poultry products. Due to this, the awareness for the health of poultry birds as well as the quality of products has also increased. Many problems arise while taking good care the poultry birds as it is a very tedious and intricate task which demands lot of alertness and minimum errors. . An automated poultry farm has been implemented by using simple microcontroller, various motors and some sensors such as- Arduino UNO, GSM Module, WIFI Module, DHT 11, MQ-5 and MQ-7 etc.

II. LITERATURE SURVEY

Chakchai So-In, Sarayut Poolsanguan and Kanokmon Rujirakull have developed the global architecture of hybrid systems for mobile and wireless network management systems for intelligent poultry sensors. One of the ideas is to distinguish the electronic and

mechanical parts of the farm in terms of mobility and flexibility.

Drishti Kanjilal, Divyata Singh, Rakhi Reddy and Jimmy Mathew,” Smart Farm: Extending Automation To The Farm Level,” Proc IJSTR, Vol. 3, no. 7,pp. 2277-8616, July.2014.

H. Okada¹, H. Nogami¹, T. Kobayashi, T. Masuda and T. Itoh⁴ have been developed with a wireless sensor button with very low power to continuously monitor the activity of animal health care. The interrupted effect of measuring body temperature is sufficient for health care and effective to reduce energy consumption.

III. BLOCK DIAGRAM

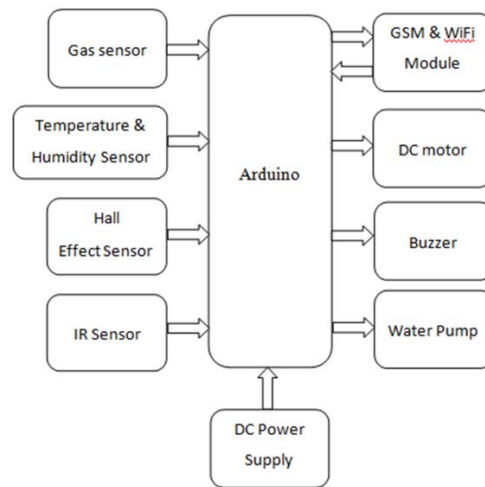

IV. METHODOLOGY

• EXISTING METHOD

The basic principle behind this technique is that the automation of poultry farm is associated with the sensor networks and GSM module. Using the different sensors like temperature sensor, gas sensor it will be

detecting the problems in the farm and it was sending an SMS to the owner by saying that these problems has been occurred in the farm. When any smoke or gas detected in the farm, SMS is sent to the owner saying that gas has been detected. Similarly, when someone tries to enter the farm without the knowledge of the owner an SMS is sent to the farmer.

• PROPOSED METHOD

For safekeeping of the chickens in the farm and for mental peace of the farmer we make use of door magnet sensor along with the GSM and Wi-Fi module protection is given to the farm. This particular system is connected to door of the main gate. When farmer is outside the farm, he/she can activate the module by simply sending the SMS using the GSM module. After successful activation, device gives the confirmation message saying that the module as been activated. When someone tries to open the main gate an alert will be sent to the farmer as well as nearest police station through SMS. System has been provided with the deactivation mechanism also when the system is not in use by sending message to the same number. In second feature a protective measure is taken against the fire and gas detection. When any gas or smoke in detected in the farm, a buzzer is set and an SMS is sent to the user as well as water will be supplied by the pump using the same mechanism used in the Anti-stealth. Fire water pump, ESP8266 WI-FI module, buzzer and Arduino are also used to control all equipment. And finally, IoT has been used to monitor important data which is the main parameter for safety of chicken like-temperature, relative humidity, light intensity and amount of gas present in the farm. IoT is used for data transmission in specified IP address of “ThingSpeak” website. Sensor collected data is stored in microcontroller and via this Wi-Fi module goes to the website.

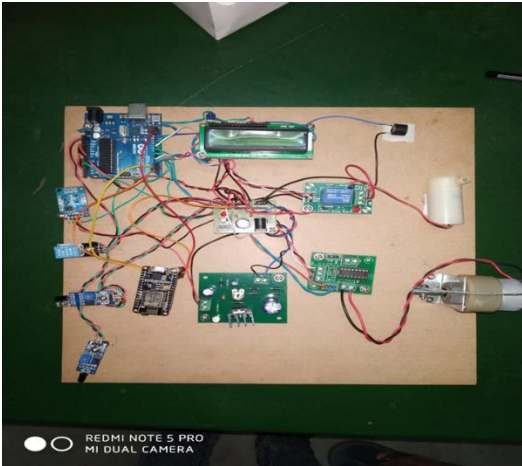
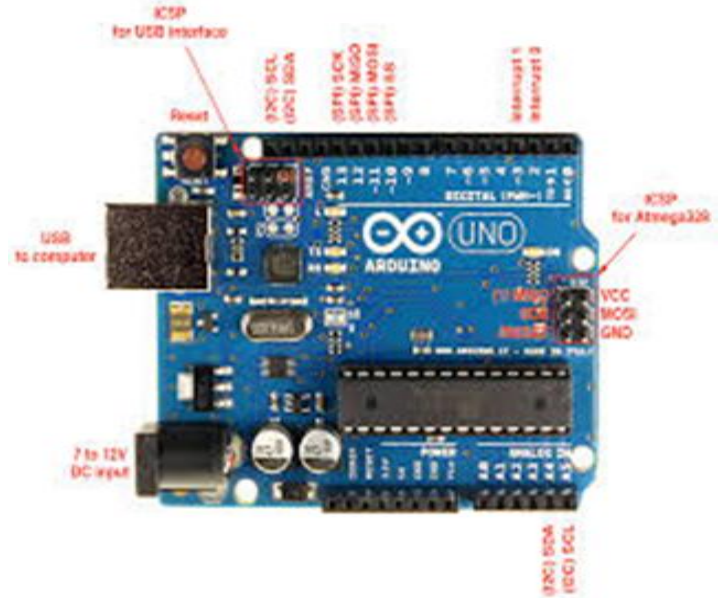

V. ARDUINO UNO

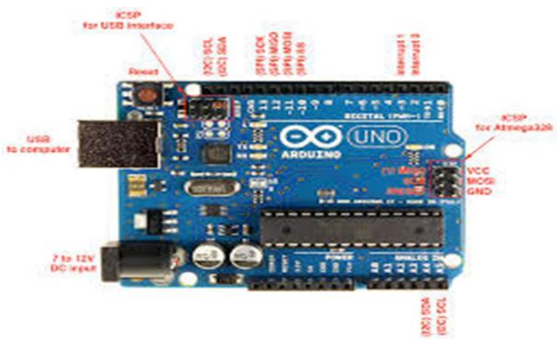

The Arduino Uno is a microcontroller board based on the ATmega328. It has 14 digital input/output pins (of which 6 can be used as PWM outputs), 6 analog inputs, a 16 MHz ceramic resonator, a USB connection, a power jack, an ICSP header, and a reset button. It

contains everything needed to support the microcontroller; simply connect it to a computer with a USB cable or power it with a AC-to-DC adapter or battery to get started.

VI. TEMPERATURE SENSOR

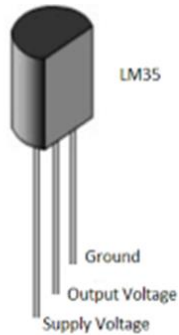

- Temperature sensors are vital to a variety of everyday products.
- For example, while temperature is generally sensed by humans as “hot”, “neutral”, or “cold”, chemical engineering requires precise, quantitative measurements of temperature in order to accurately control a process. This is achieved through the use of temperature sensors, and temperature regulators which process the signals they receive from sensors.

VII. GAS SENSORS



The onboard microcontroller provides initial heating interval after power up and then starts to measure LPG sensor output. If it found the LPG contents above settled value, it will inform the Host controller by pulling the Output Pin to High and Starts to blink an onboard status LED.

VIII. HUMIDITY SENSOR



A humidity sensor (or hygrometer) senses, measures and reports both moisture and air temperature. The ratio of moisture in the air to the highest amount of moisture at a particular air temperature is called relative humidity. Relative humidity becomes an important factor when looking for comfort.

IX. HALL EFFECT SENSOR

A Hall effect sensor is a device that is used to measure the magnitude of a magnetic field.

Hall effect sensors are used for proximity, sensing, positioning,

Speed detection and current sensing application. Commonly seen in industrial applications such as the pictured pneumatic cylinder, they are also used in consumer equipment

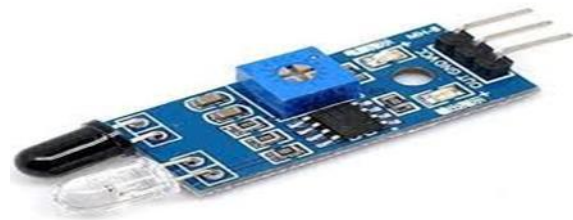

X. IR SENSOR

The IR sensor module designed here has an IR emitter and an IR receiver. The emitter is simply an IR LED and the detector are simply an IR photodiode which is sensitive to IR light of the same wavelength as emitted by the IR LED. When IR light falls on the photodiode, the resistance and the output voltage change in proportion to the magnitude of the IR light received.

XI. DC MOTOR

Electric motors are everywhere! In your house, almost every mechanical movement that you see around you is caused by an AC (alternating current) or DC (direct current) electric motor.

How do we make a motor turn?

You take a battery; hook the positive side to one side of your DC motor. Then you connect the negative side of the battery to the other motor lead.

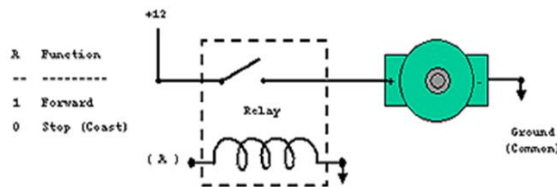

Figure: Connections for clockwise rotation of motor

If you connect this circuit to a small hobby motor you can control the motor with a processor (MCU, etc.) Applying a logical one, (+12 Volts in our example) to point A causes the motor to turn forward.

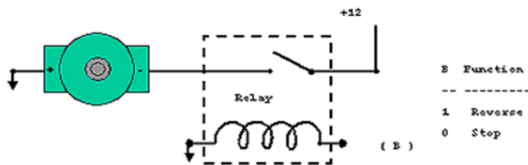

Figure: connections for anti- clockwise rotation of motor

Hook the motor up in this fashion and the circuit turns the motor in reverse when you apply a logical one (+12Volts) to point B. Apply a logical zero, which is usually a ground, causes the motor to stop spinning.

XII. L293-D DRIVER CIRCUIT



Pin Configuration:

1. Enables and disables the motor whether it is on or off (high or low)
2. Logic pin for the motor (input is either high or low)
3. Is for one of the motor terminals can be either +/-
4. Ground
5. Ground
6. Is for the other motor terminal
7. Logic pin for our motor (input is either high or low)
8. Power supply for the motor
9. Enables and disables the 2nd motor on or off (high or low)

XIII. BUZZER



Sounds commonly used to indicate that a button has been pressed are a click, a ring or a beeps.

Applications:

- Gas alarms, burglar alarms, smoke detectors.
- Air conditioners, Microwave ovens, washing machines and another home-electronic appliance controlled by microcomputer.
- Bicycles, toys, game machines.

XIV. POWER SUPPLY

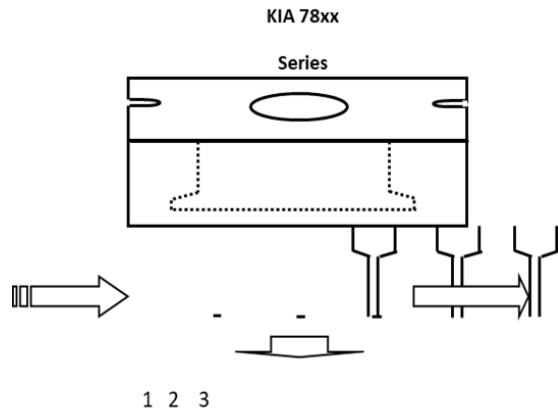

The circuit needs two different voltages, +5V & +12V, to work. The stabilization of DC output is achieved by using the three terminal voltage regulator IC. This regulator IC comes in two flavors: 78xx for positive voltage output and 79xx for negative voltage output.

XV. WIFI MODULE

The ESP8266 is a low-cost WI-FI microchip with full TCP/IP Stack and micro-controller capability.

This small module allows microcontrollers to connect to a Wi-Fi network and make simple TCP/IP connections

The RESET and VCC pins of the module are connected to the 3.3 V DC while Ground pin is connected to the common ground. The TX and Rx pins of the module are connected to the 2 and 3 pins of the Arduino UNO The ESP8266 Wi-Fi Module is used to connect the Arduino board with a Wi-Fi router, so that it can access the cloud.



XVI. RESULT

In this paper we have proposed a solution device to the given problems at the concerned poultry farm. The control for water and feed supply is done along with real time observation of the temperature and humidity at the farm. This is done using Node MCU ESP8266 for providing a Wi-Fi connection, Relay Module and L293D Motor Driver for controlling of motors of feed and water supply. DHT11 Sensor for the observation of temperature and humidity levels at the farm. This methodology can be further used with modifications and connecting to other devices at the farm and controlling various physical parameters at the place.

CONCLUSION

This automated system can be very useful for farmers as they can easily access and control the system remotely using their handheld mobile devices. The system also saves time, optimizes resource utilization and increases poultry production. Further in the near future, using more advanced sensors and technological concepts, all the environmental output data can be collected in a more reliable state. This will enable anyone with minimum farming knowledge to start up a poultry business. Hence, the future demand for chicken-meat and the economic growth of any nation will be hugely benefited.

REFERENCES

- [1] Pravina B. Chikankar, Deepak Mehetre and Soumitra Das," An Automatic Irrigation System using ZigBee in Wireless Sensor Network," Computer Engineering Department K J College of Engineering & Management Research, Pune, India. -2015.
- [2] Archana M P, Uma S K and Raghavendra Babu T M," Monitoring and Controlling Of Poultry Farm Using IOT," Proc IJIRC, Vol. 6, Issue 4, April 2018, pp-2320-9798.
- [3] Drishti Kanjilal, Divyata Singh, Rakhi Reddy and Jimmy Mathew," Smart Farm: Extending Automation to The Farm Level," Proc IJSTR, Vol. 3, no. 7, pp. 2277-8616, July.2014.

- [4] Joseph L. Purswell, William A. Dozier III, Hamed A. Olanrewaju, Jeremiaah D. Davis, Hongwei Xin and Richard S. Gates,” Effect of Temperature-Humidity Index on Live Performance in Broiler Chickens Grown From 49 To 63 Days of Age,” Proc. ASABE, July. 2012.