

# Design And Analysis of a Ship Hull

J. SURESH BABU<sup>1</sup>, R. MAHESH<sup>2</sup>, DR. D. RAVIKANTH<sup>3</sup>, C. MOULA<sup>4</sup>, E. NAGA MAHESWAR REDDY<sup>4</sup>, Y. HARINATH REDDY<sup>6</sup>

<sup>1,2</sup> Assistant Professor, Department of ME, KSRMCE (Autonomous), Kadapa, AP, India.

<sup>3</sup> Professor & HOD, Department of ME, KSRMCE (Autonomous), Kadapa, AP, India.

<sup>4,5,6</sup> Student, Department of ME, KSRMCE (Autonomous), Kadapa, AP, India.

**Abstract-** The objective of the present thesis is to study the structural behavior of a ship hull structures subjected to bending, shearing and torsion by using finite element solutions. And one of the most active fields of ship hydrodynamics research today is the development of methods for computing the drag coefficient of the steady, free-surface, viscous flow around a ship hull. Experimental tests are often used as a reliable method for the prediction of ship performance. Nowadays, with the development of new numerical tools, advancements in computer technology and improved data processing capabilities, Computational Fluid Dynamics (CFD) has made remarkable progress. This has allowed ship designers to create a computer-generated model of a ship and check its performance, at various speeds, in a simulated environment, for subsequent optimization processing. The results from the CFD simulations are necessary to understand the complicated flow characteristics for an optimal hull design and to establish low drag and high propulsive efficiency. This allows the designers to predict if the total resistance of the ship is at an acceptable level. This project describes a Computational Fluid Dynamics (CFD) Analysis of a ship hull design

**Indexed Terms-** ANSYS, CFD Analysis, Finite element method, open deck structures, SHIP-HULL, SOLID-WORKS 2016.

## I. INTRODUCTION

Ship structure design and analysis has always been a very important and active field of scientific research, in an effort to make those structures more reliable and cost effective. Much of this work was initially aiming to develop methods to determine the hull girder strength, and although these early methods gave adequately safe designs for common ship structures it

has been shown by full-scale tests that the mechanisms of failure were frequently different from the predictions of those methods. The major cause for that discrepancy is the non-linear behavior of the individual components and subsequently the entire system. These observations led to an increasing concern with the local phenomena as opposed to the global phenomena. A Great amount of research was devoted then to the Ultimate strength and behavior of individual ship structural components such as individual plates, stiffened plates and grillages (figure). Based on the knowledge of these individual components, various methods were developed in an attempt to determine the ultimate strength for the entire ship hull.

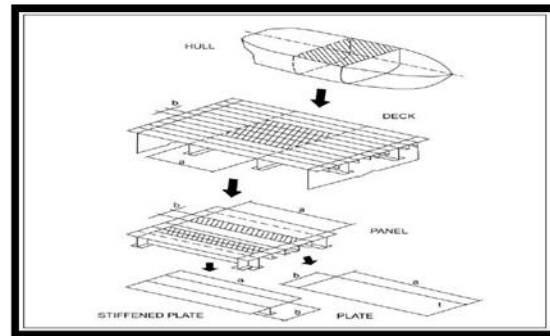

Fig: Ship hull girder as box-like thin-walled stiffened structure.

From a variety of methods, one of the most exhaustive is the one developed by Ostapenko, where the behavior and ultimate strength of longitudinal stiffened ship hull girder segments of rectangular single-cell cross section, subjected to bending, shear and torque, were analyzed analytically and tested experimentally.

This method produces accurate results for the bending and shear load cases, but not so acceptable results

when torsion is considered (up to 40% of overestimation).

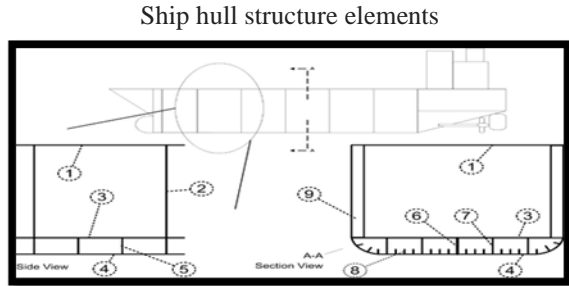

Fig: Structural Elements of a Ship's Hull

The above diagram shows the key structural elements of a ship's main hull (excluding the bow, stern, and deckhouse).

1. Deck plating (a.k.a. Main Deck, Weather deck or Strength Deck)
2. Transverse bulkhead
3. Inner bottom shell plating
4. Hull bottom shell plating
5. Transverse frame (1 of 2)
6. Keel frame
7. Keelson (longitudinal girder) (1 of 4)
8. Longitudinal stiffener (1 of 18)
9. Hull side beam

## II. AIM AND SCOPE

The aim of this thesis is to study the overall structural behavior of open deck ship hull configurations and computational fluid dynamics (CFD). This analysis is performed using the finite element method upon a simplified structural arrangement.

Furthermore, a particular focus is made on the analysis under torsional loading, where another relevant aspect is discussed and an alternative method of analysis is tested. The mentioned aspect is an attempt of quantifying the differences in the structural response i.e., developed stresses and displacements, between open deck, partially-closed and closed deck structural configurations.

## III. CASE STUDY

Mid-ship section: The mid-ship section used for this study is a simplification of the one taken, where the main dimensions are given in below

### Main dimensions of deck [m]

Length, $L_{bp}$	152.9
Beam, $B$	26.0
Depth, $D$	16.2
Draft, $T$	10.8

The block co-efficient,  $C_B$ , is not given, and for all computations where is required, it is assumed a typical block co-efficient for a container ship, as  $C_B = 0.65$ .

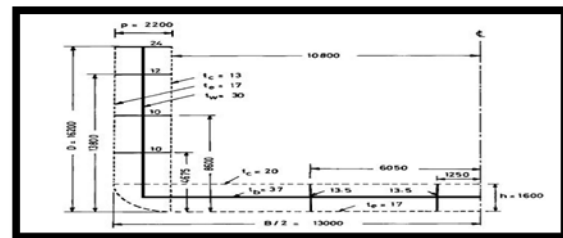

Figure: Midship section layout.

Fig. presents the original mid-ship section layout in a dashed line, and in a bold line is this implication that will be used further in the present study. From this mid ship section layout, a further simplification is made, regarding the bilge. In order to simplify the construction in the finite element model, the curved bilge was replaced by a rectangular bilge. Also, some modifications have been made, regarding the thicknesses of some segments of the cross-section, in order to fulfill the minimum section modulus, according to the DNV - Det Norske Veritas structural rules.

Table presents the mid-ship cross-sectional properties after all the supra mentioned simplifications.

Area, $A[m^2]$	2.37
1 <sup>st</sup> moment of area, $S[m^3]$	13.45
Neutral axis, $Z_{NA}[m]$	5.67
2 <sup>nd</sup> moment of area, $I_{yy}[m^4]$	154.18
2 <sup>nd</sup> moment of area, $I_{NA}[m^4]$	77.94
2 <sup>nd</sup> moment of area, $I_{zz}[m^4]$	249.47
Section modulus, $Z_{deck}[m^3]$	7.40
Section modulus, $Z_{bottom}[m^3]$	13.75
Section modulus, $Z_{side}[m^3]$	19.19

Required section modulus,  $W_{min}[m^3]$  7.36

To define the position of the shear center, a further approximation is used, as shown in Fig. and expressed in Eqn.

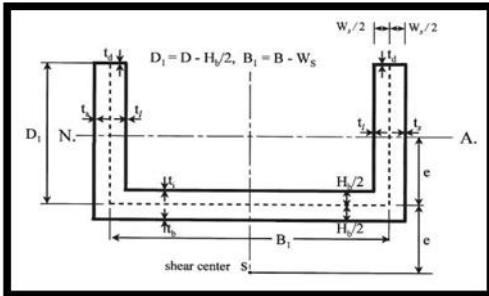

Figure: Simplified cross-section.

The equivalent thicknesses are defined applying a procedure that consists in redistributing the net sectional areas of the internal girders by their attached plate, and further dividing the new areas by the length of the correspondent segment, obtaining in this way a uniform thickness for each segment. Once this is done, the estimated thicknesses, as well as the shear center position, are given in Table

$D_1[m]$	15.40
$B_1[m]$	23.80
$t_s[mm]$	22.16
$t_i[mm]$	16.14
$t_b[mm]$	19.46
$t_i[mm]$	23.00
$e[m]$	9.07

In respect to the original coordinate system, the shear center is located at the center line of the section at the coordinate  $z = 8:27m$ .

• Element type

The type of elements used is the 8-node quadrilateral shell element it allows six degrees of freedom at each node (translations in the nodal x, y and z directions and rotations about the nodal x, y and z-axes). This type of element has plasticity, stress stiffening, large

deflection, and large strain capabilities. This set of characteristics makes this type of element the most suited for this application. In ANSYS this type of element is designated as SHELL93.

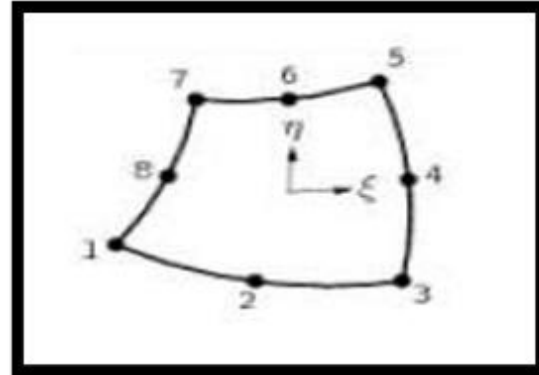

Figure: Quadrilateral 8-node shell element.

• Boundary conditions

To simulate the interaction between the finite element model of the hull segment with the rest of the ship hull, the nodes along the lines of one of the ends are constrained in every degree of freedom, while all other nodes are kept free, such as in a cantilever beam.

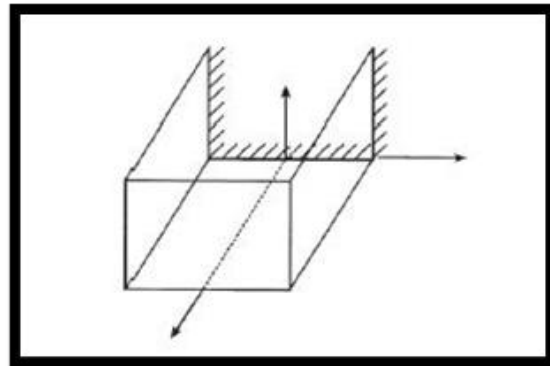
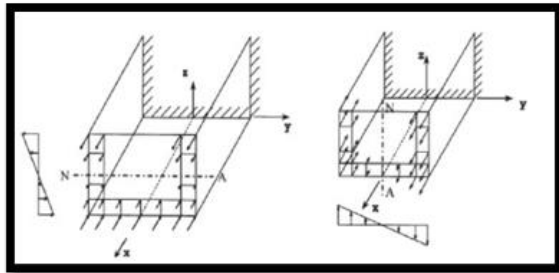

Figure: Boundary conditions applied to the cargo hold length model.

• Applied loads

To model the overall loads to which the finite element model is subjected, it is necessary to transform the loads in equivalent distributed loads or equivalent set of nodal loads and apply them to the specific nodes of the meshed finite element model of the ship hull. Knowing the bending moment and the second moment

of area about the neutral axis of the cross-section, it is possible to determine the normal stresses at any given point.



(a) (b)  
Fig.: Equivalent vertical (a) and horizontal (b) bending moments.

- Other loads on ship hull
- The hulls of ships are subjected to a number of loads.
- Even when sitting at dockside or at anchor the pressure of surrounding water displaced by the ship presses in on its hull.
  - The weight of the hull and of cargo and components within the ship bears down on the hull.
  - Wind blows against the hull, and waves run into it.

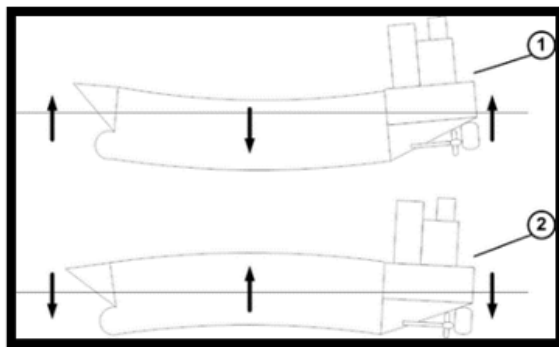

Fig: Diagram of ship hull (1) Sagging and (2) Hogging under loads. Bending is exaggerated for illustration purposes.

1. Down in the center, known as sagging
2. Up in the center, known as hogging.

#### IV. METHODOLOGY

The designed Deck and Small ship model by using Dassault Systems Software. The designed part was import to the ANSYS workbench. In the ANSYS workbench software the material was selected. In this

paper, wood, plastic, stainless steel or carbon fiber was selected in the ANSYS workbench software.

- 3D MODEL OF A DECK STRUCTURE

The 3D model of the Deck structure is created using CATIA V5 software from the 2d drawings.

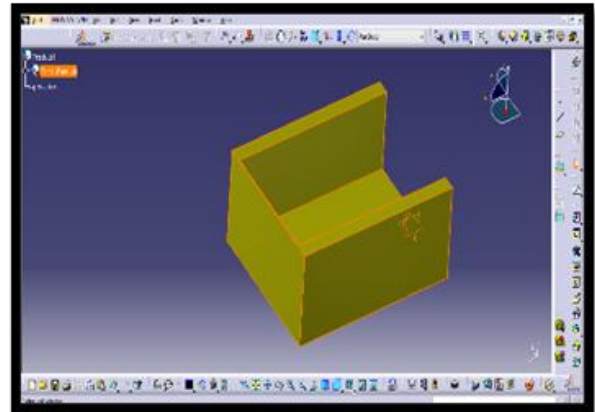

Fig: 3D Model of a deck structure.

- 2D Model of Ship Hull

The basic model of a ship hull, drafting different views of a ship hull is shown in below.

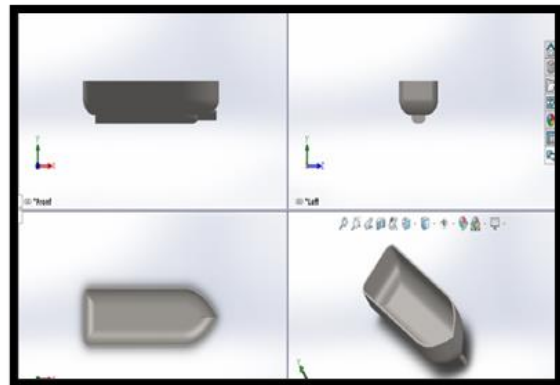
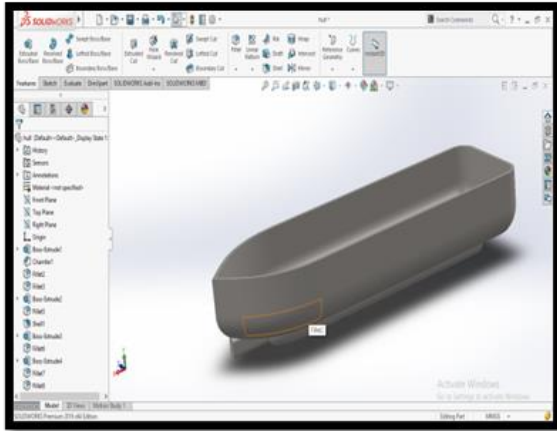

Fig: Different views of a model.

- 3D Model of Ship Hull

The basic model of a ship hull is developed using solid works software and is shown in below figure.



3D model of a ship hull.

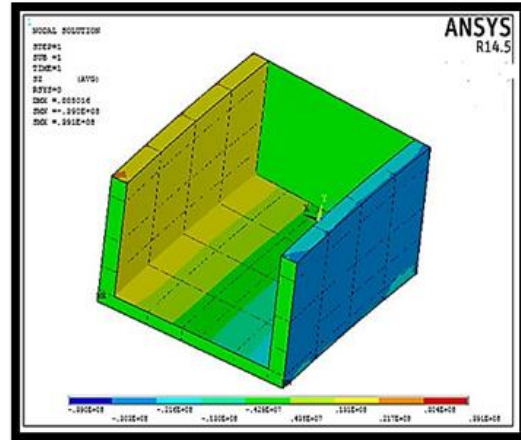

Figure: Axial stresses under horizontal bending moment.

## V. STRUCTURAL ANALYSIS

Structural analysis of deck structure:

Bending movement of deck structure:

1. Vertical bending moment:

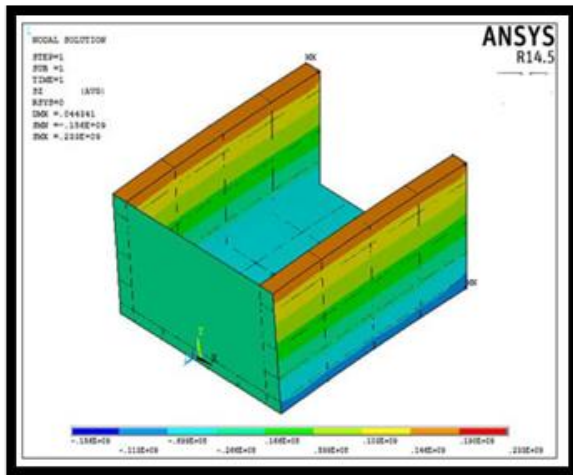

Figure: Axial stresses under vertical bending moment.

2. Horizontal bending moment:

*Ship hull structure subjected to Shear load*

1. Vertical shear forces:

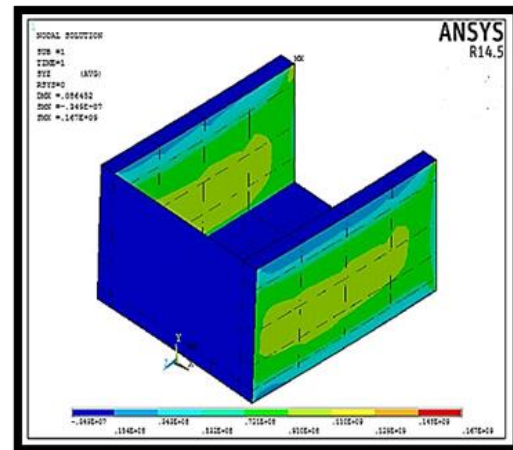

Fig: ZX shear stress component

2. Horizontal shear forces

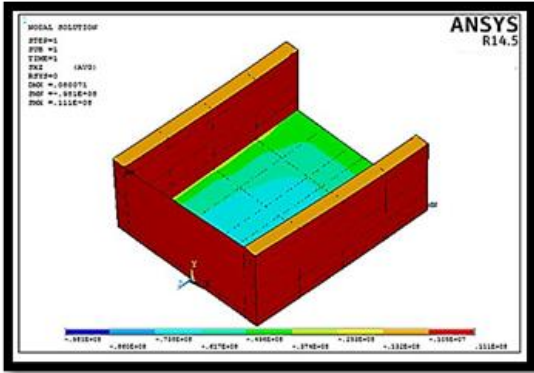
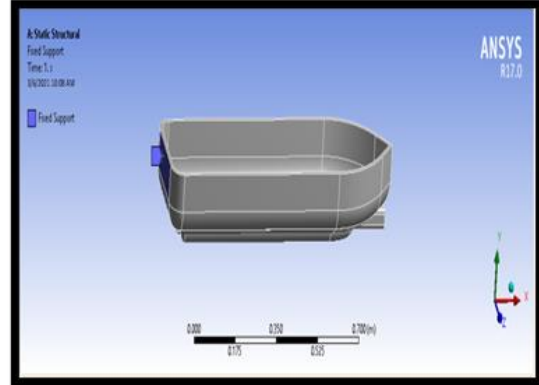

Figure: YX shear stress component.



Fixed support

*Structural analysis of open ship hull:*

Model generation: For this analysis, the whole simplified ship hull structure is modeled. The model consists on the replication of the model used in the previous sections, in such way that it now forms a cylindrical body with 122.32 meters length. Also simplified symmetric bow and stern closings with closed cross-sections are modeled, creating a 154.81 meters length overall barge-like model.

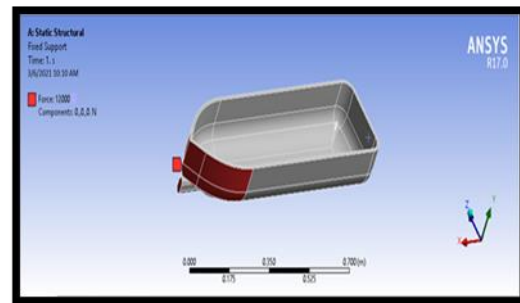

Direction of force applied.

Boundary conditions and applied loads

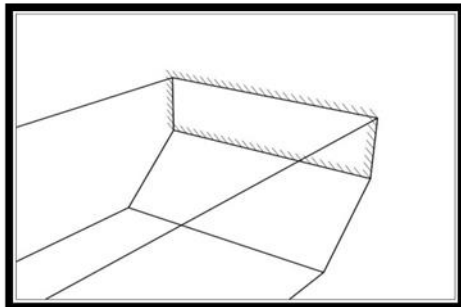

Boundary conditions.

Boundary conditions are applied to an open ship hull, for a static analysis is shown in below figures the rare portion is assumed as fixed and Force applied in the front portion of a ship hull, the applied force acts on the colored region.

Results of structural analysis:

Deformation: Change in the shape of the body subjected to the force, and deformation is proportional to the stress applied within the elastic limits of the material.

“Total deformation is the vector sum all directional displacements of the systems”.

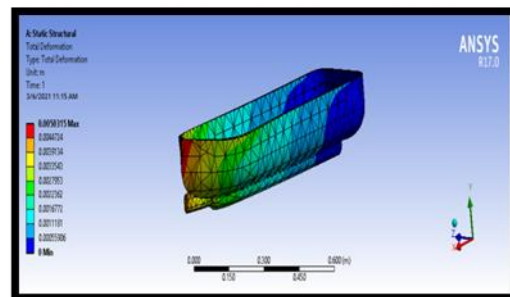

Total deformation

The maximum deformation recorded here is 0.0050315 meters.

Equivalent stress

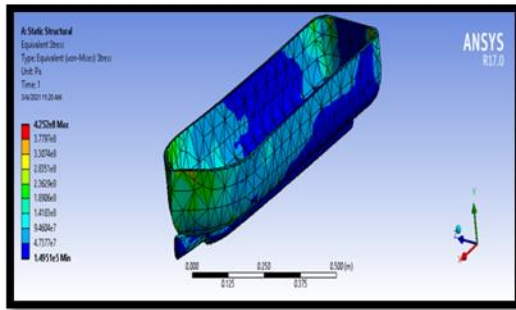

Equivalent/von –mises stress

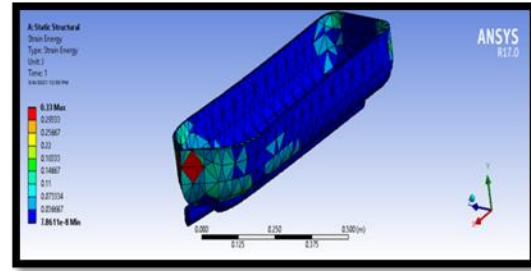

Strain energy

Equivalent elastic strain

Maximum -principle stress

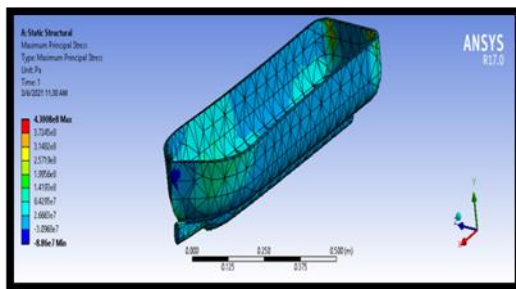

Maximum principle stress

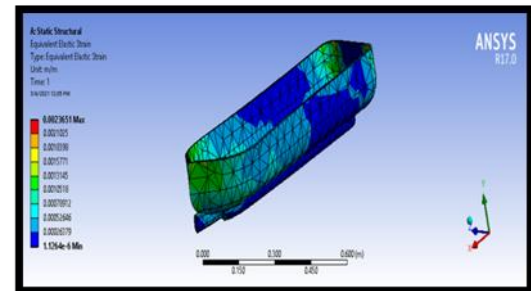

Equivalent elastic strain

The minimum principle stress is  $-8.86e7$ pa and the maximum stress is  $4.300e8$  pa.

Shear elastic strain in xy plane

Shear stress in xy plane

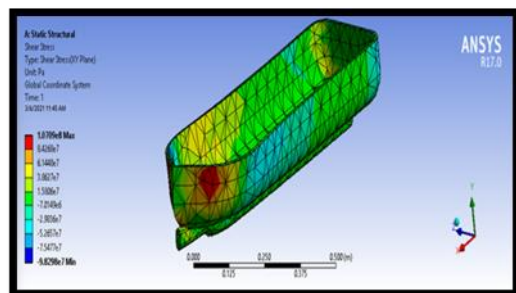

Shear stress in xy plane

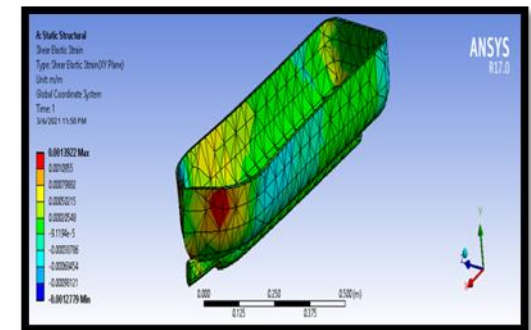

Shear elastic strain

The maximum shear elastic strain in xy plane is 0.0013922 and the minimum shear elastic strain is -0.0012779.

The min shear stress is  $-9.825e7$ pa and maximum is  $1.070e8$  pa.

## VI. CFD ANALYSIS OF SHIP HULL

Strain energy

In this study, the initial geometry (iteration 1) is as s the ship with fixed draft level. The initial flow conduit Recommended Procedures and Guidelines. The CFD analysis for the modified hull (iteration 2) consistency in the solution.



- 1) Preparing the CAD geometry for CFD meshing
- 2) Meshing
- 3) Solution setup and checking, including convey
- 4) Post-processing and reporting the analysis in this project was performed us

**Geometry:**

The initial geometry (iteration 1) and the model was imported into ANSYS Design Modeler as in Fig. A large fluid domain was created to ensure advantage of the symmetry plane. The size of the domain can be seen in Fig.

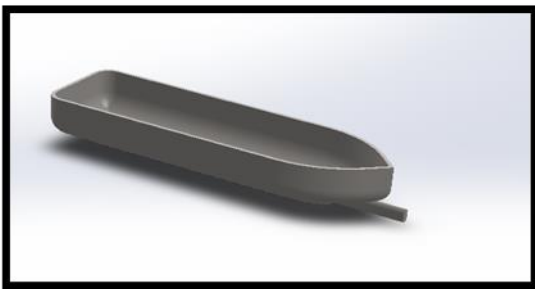

Ship hull design

**Mesh generation**

Table 1: Mesh Information

Finite Volume Model (CFD Mesh)	Number of elements
Hull CFD domain (Half Model)	4,000,000

mesh information

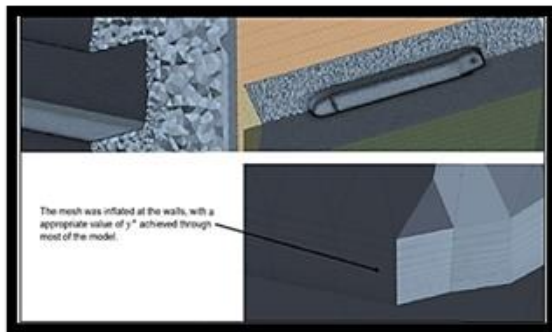

Mesh near the corners

Property	Air	Sea-water
Density (kg/m <sup>3</sup> )	1.18	1010
Dynamic viscosity (kg/ m-s)	1.8e-5	8.9e-4

Fluid properties

**Drag coefficient:**

“It is the dimensionless quantity that is used to quantify the drag or resistance, such as air or water. The C<sub>D</sub> is always associated with a particular surface area”.

Drag coefficient is given by,

$$\text{Drag Coefficient: } C_D = \frac{F_D}{\frac{1}{2} \rho_w v_\infty^2 A_w}$$

Where, F<sub>D</sub> = Drag Force, ρ<sub>w</sub> = 1010 kg/m<sup>3</sup> (water density), V<sub>∞</sub>, Vm/s (freestream velocity),

A<sub>w</sub> ≈ area m<sup>2</sup> (wet surface), Power P = F<sub>D</sub> . V<sub>∞</sub>

**Total resistance:**

The force that the ship experiences opposite to the motion of the ship as it moves. The total resistance is the sum of the viscous resistance, wave making resistance and air resistance.

Total resistance, RT = R<sub>V</sub>+ R<sub>W</sub>+R<sub>A</sub>

Where, R<sub>V</sub>=viscous resistance,

R<sub>W</sub>=wave making resistance,

R<sub>A</sub>=air resistance.

**Boundary Conditions:**

A two-phase steady state CFD analysis was carried out. the free stream velocity of both water and air was set equal to the ship hull velocity with the considered as an immovable rigid body. Atmospheric pressure was assigned to the air phase and hydrodynamic pressure distribution was to assigned to be water phase. a no slip wall boundary conditions was assigned to the ship hull. The initial draft level was set equal to 6000m.the analysis was carried out at clam sea condition

Boundary conditions shown below

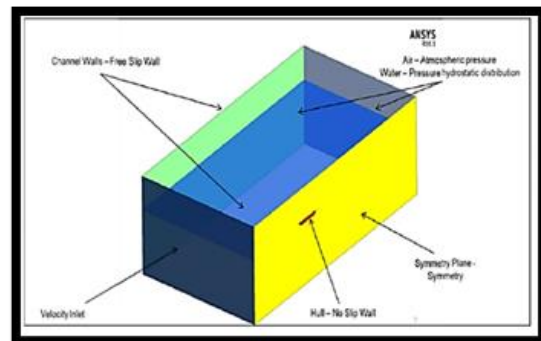

Boundary Conditions



**Solution options**

The analysis was carried out using ANSYS fluent. The volume of fluid multiple phase model was the free surface flow. The flow simulation was run as a steady state analysis solving the Reynolds-Averaged Navier Stokes equations along with the k-omega SST turbulence model.

**Input conditions:**

Here the two iterations is carried out by changing in the pressure force applied, in iteration1 pressure force is taken as 139KN and to improve the out put conditions in iteration 2 pressure force is raised to 142KN.

Input	Iteration 1	Iteration 2
Pressure force	139KN	142KN

input conditions

**Results of CFD:**

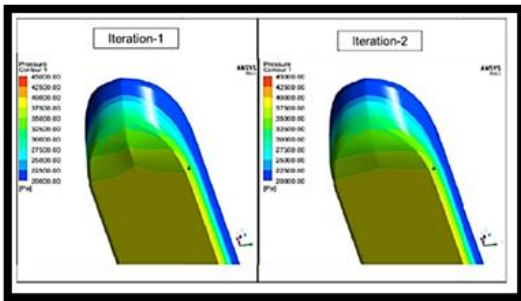
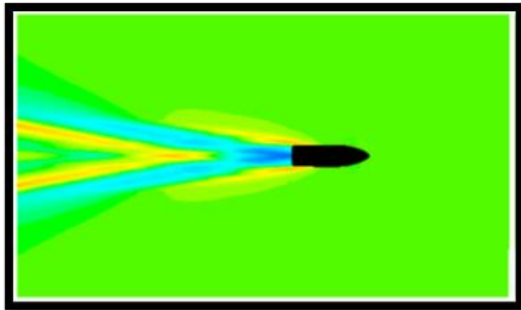
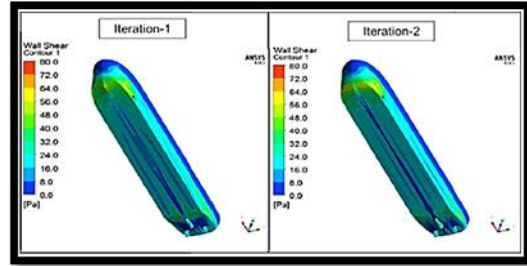

Fig. Pressure near the propeller region

**Wall shear contour on the hull surface:**



Wall shear contour on the hull surface

**Total pressure distribution along the ship hull centerline:**

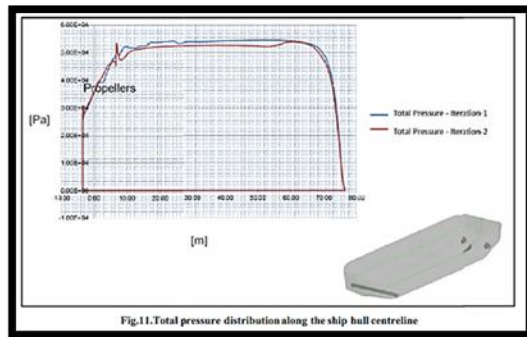

Fig.11.Total pressure distribution along the ship hull centerline

**Shear stress distribution along the ship hull centerline**

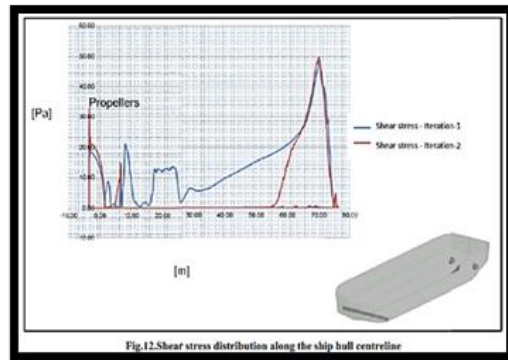

Fig.12.Shear stress distribution along the ship hull centerline

**STREAM LINES AND TURBULANCE:**

A Streamline is a path traced out by a mass less particle as it moves with the flow. It is easiest to visualize a streamline if we move along with the body. The fig shows the computed streamlines around an airfoil and around a cylinder or across a ship.

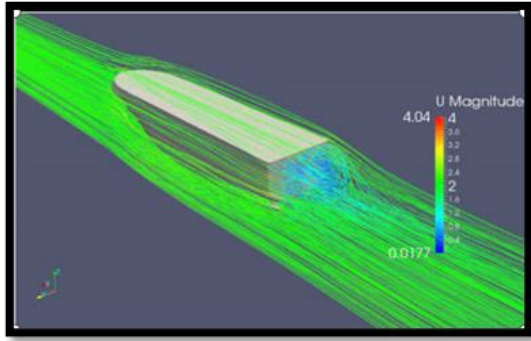
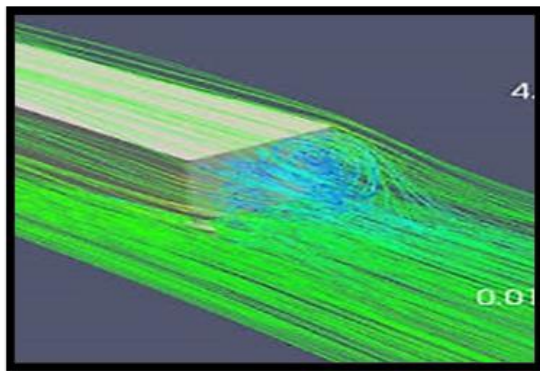

Fig. Stream lines

Turbulence is a flow regime in fluid dynamics characterized by chaotic changes in pressure and flow velocity. It is in contrast to a laminar flow regime, which occurs when a fluid flows in parallel layers, with no disruption between those layers.



Turbulence at back side of ship hull

## VII. RESULTS

Structural analysis of a open ship hull:

s.no	Result	Minimum	Maximum
1	Deformation	0 m	0.005035 m
2	Equivalent (von-mises)stress	1.4951e5 Pa	4.252e8 Pa
3	Max-principle stress	-8.86e7 Pa	4.3e8 Pa
4	Shear stress	-9.825e7 Pa	1.0709e8 Pa
5	Strain energy	7.8611e-8 J	0.33 J

6	Equivalent elastic strain	1.126e-6	0.002368
7	Shear elastic strain	-	0.00392
		0.0012779	

Results of structural analysis

CFD Analysis of a open ship hull:

S no	Result	Iteration 1	Iteration 2
1	Viscous force	42 KN	39KN
2	Total resistance	179KN	175KN
3	Drag coefficient	0.0069	0.0055
4	Power	895KW	710KW

Results of CFD analysis

## CONCLUSION

- In this project, the simplified deck structured and open ship hull were created by using solid works software and imported to ANSYS software.
- Solution is done through finite element solver with the initial model and varies parameters such as stress, strain, deformation is calculated.
- Results of structural analysis is shown in table:
- CFD Analysis is carried out in two iterations by varying pressure force
- High values of the wall shear stresses and the skin friction were observed near the propellers and the front section of the ship hull for iteration 1
- The computed total drag force for iteration 1 was 179 kN. The drag coefficient was found to be 0.0069. The power needed to overcome the aerodynamic resistance produced by the fluids was 895 kW.
- The computed total drag force was 175kN for iteration 2. The drag coefficient was found to be 0.0055. The power needed to over-come the aerodynamic resistance produced by the fluids was 710 kW.

However, the modification carried out for iteration-2 improved the shear stress plot along the centre-line of the ship

The smoothening of hull surface near the front area may reduce the drag forces and improve the performance of the SHIP

The propellers and the front area of the ship are the main regions offering maximum resistance to ship. The propellers were not modeled in detail in this study. However, further localized study may be performed to analyze the flow through the propellers.

torsion,” *Ocean Engineering*, vol. 28, no. 8, pp. 1097–1133, 2001.

- [10] H.-H. Sun and C. G. Soares, “An experimental study of ultimate torsional strength of a ship-type hull girder with a large deck opening,” *Marine Structures*, vol. 16, no. 1, pp. 51–67, 2003.
- [11] *Finite Element Computational Fluid Mechanics*, A.J. Baker, Hemisphere Publishing corporation.

#### BIBLIOGRAPHY

- [1] *Computational Methods For fluid Dynamics*, Joel H. Ferziger and Milovan Peric,
- [2] 3<sup>rd</sup>edition, spinger publications and distributors.
- [3] Dunna Sridhar, T V K Bhanuprakash and H N Das, 2010, *Frictional Resistance Calculations on a Ship using CFD*, *International Journal of Computer Applications* (24 – 31), Volume 11(5)
- [4] *Advanced engineering Fluid Mechanics*, K Muralidhar, Gautam Biswas. Second edition Narosa publishing house, New Delhi.
- [5] Bertram. V (2014), *Practical Ship Hydrodynamics*, Second Edition.
- [6] Krishna Atreyapurapu, Bhanuprakash Tallapragada and Kiran Voonna, 2014, *Simulation of a Free Surface Flow over a Container Vessel Using CFD*, *International Journal of Engineering Trends and Technology*, (334-339), Volume 18(7).
- [7] A. Ostapenko and T. R. Moore, “Maximum strength of ship hulls subjected to moment, torque and shear,” tech. rep., Lehigh University, Fritz Laboratory Reports, 1982.
- [8] D. Hong and O. Kim, “Analysis of structural damage of a large ore/coal carrier,” in *Ship Technology and Research Symposium (STAR)*, 12th, 1987.
- [9] J. K. Paik, A. K. Thayamballi, P. T. Pedersen, and Y. I. Park, “Ultimate strength of ship hulls under