

Improving the Performance Analysis of MIMO-OFDM System using different Antenna Configurations

R. TEJASWINI¹, B. JAHNAVI², B. SAI DEEPTHI³, G. HANSA LEKHA⁴, D. THRIVENT⁵

¹ Assistant Professor, Department of Electronics and Communication Engineering, Vasireddy Venkatadri Institute of Technology, Guntur, AP, India.

^{2, 3, 4, 5} Student, Department of Electronics and Communication Engineering, Vasireddy Venkatadri Institute of Technology, Guntur, AP, India.

Abstract- *The main challenge faced by upcoming wireless communications systems is to provide high-data-rate wireless access at high quality of service (QOS). Multiple-input multiple output (MIMO) wireless technology achieves these demands by increasing the bandwidth efficiency through spatial multiplexing gain by improving link reliability due to diversity gain of antenna. Antenna arrays may be integrated with OFDM at the transmitter and receiver to increase Spectral efficiency and enhance robustness using multipath signal propagation, which results in a MIMO-OFDM configuration. The power leaving algorithms along with forward error correction (FEC) plays an important role in the performance improvement of the MIMO-OFDM systems. In this paper a simple MIMO OFDM system with convolutional coding is designed and performance of the system is analyzed using different antenna configuration in AWGN channel. It was concluded that higher antenna configuration gives the best performance.*

Indexed Terms- BER, FEC, MIMO, OFDM, QOS, high data rate, link reliability.

I. INTRODUCTION

The performance of wireless communication systems is especially ruled by the wireless channel surroundings. In recent years, improvement of the wireless communication system has become crucial with the rapid climb of mobile communication services and rising broadband mobile net access services. The most challenge faced by coming wireless communications systems is to produce high-data-rate wireless access at top quality of service (QOS). Propagation conditions aren't satisfactory because of

interference and weakening from alternative users and spectrum is restricted supply. MIMO with OFDM reduces the exploit complexities by transmission completely different knowledge on different frequency levels to realize spectral potency and error recovery options, which is able to supply high spatial rate by transmission knowledge on multiple antennas and transmission in Non-Line-of sight (NLOS). Thus, the MIMO-OFDM technique is employed to attain diversity. MIMO-OFDM systems have active educational community from leading trade corporations and have attracted significantly. The MIMO system with additional variety of antennas at the transmitter and therefore the receiver helps link capability. The capability is proportional to the rank of MIMO channel. Whereas high information measure potency may be obtained through spatial multiplexing, several alternative MIMO systems edges like increased signal quality and coverage may be accomplished via spatial diversity, interface cancellation and beam forming house time cryptography. Orthogonal frequency-division multiplexing (OFDM) could be a digital modulation within which the information streams every of them transmitted on separate subcarriers by cacophonous into N parallel streams of reduced rate. OFDM has been around for regarding forty years and it absolutely was initial introduced within the Nineteen Sixties and Nineteen Seventies throughout analysis by minimizing interference among channels close to one another in frequency. OFDM has been projected as a way for transmission over wireless links in multipath environments to support high-speed knowledge transmission.

MIMO system is combined with OFDM technique the specified system necessities, like smart coverage in high peak knowledge rates, reliable transmission, non-

line-of-sight surroundings and high peak knowledge rates further as high spectral potency, could also be consummated.

II. LITERATURE REVIEW

Most of the wireless communication systems have been using Single Input Single Output (SISO) systems wherever one transmit (Tx) antenna is used for transmission to one receive (Rx) antenna. Further sending a greater number of antennas at transmitting end and receiving end provides better result at the receiver end. MIMO techniques have basically three classes. First class is to increase the spatial diversity to enhance the ability potency. While, the opposite class aims to increase the capability by layered technique. Lastly, by knowledge the properties of the transmission channel; the third category analyses the constant matrix of the channel and uses these analyzing unitary matrices as filter in transmitter and receiver to enhance the capability. MIMO wireless systems make use of multiple transmitter and receiver antennas to increase capacity of the system by means of spatial multiplexing, creating use of identical frequency resources that might be used by a SISO system. As crucial commonplace SISO systems, MIMO systems show pride in multipath propagation and multiply transfer rates by taking advantage of random attenuation and multipath delay unfold. to boot, MIMO provides abstraction diversity every at the transmitter and so the receiver, so rising the transmission quality in terms of the bit-error rate (BER). so as to extend the spectral potency and to maximise the secret writing gain, ASTC are planned for MIMO flat weakening channels. To manage the frequency property, they use the OFDM modulation. They associate the performances of an ASTCMIMO-OFDM system in terms of BER. It will well manage the trade-off among rate, diversity and decipherment complexness of space-time continuum block codes. During this analysis work, a style criterion of full-diversity space-frequency codes (SFC) area unit planned for MIMO-OFDM systems with the PIC cluster decipherment.

A. MIMO

Wireless channel contains totally different impairment to transmitted signal and channel response. It affects the signal to travel in multipath between transmitter

and receiver. The multipath affects and delay profile scale back the channel potency, through place and cause corrupted info at receiver. Showing intelligence multipath result of MIMO is employed to extend capability of system. Space-Time Code is a powerful scheme that combines coding with transmit diversity to achieve high diversity performance in wireless systems. In this work, we present the Alamouti code encoder. The Alamouti code encoder is illustrated in Figure 5 where the information bits are first modulated using an M-array modulation scheme. The encoder then takes a block of two modulated symbols X_1 and X_2 each encoding operation and passes it to the transmit antennas according to the code matrix,

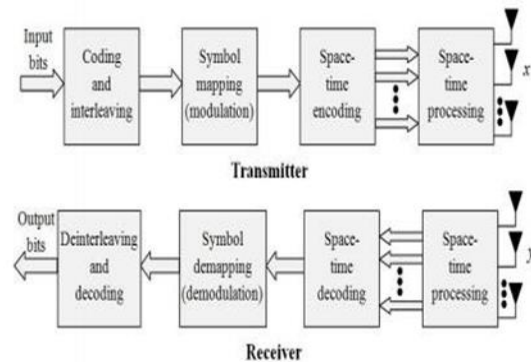

Fig 1 Block Diagram of MIMO

B. OFDM

Uses multiple subcarriers however the subcarriers area unit closely spaced to every different while not inflicting interference, removing guard bands between adjacent subcarriers, all the sub carrier's area unit orthogonal to every different. Rather than transmit a high-rate stream of information with one carrier, OFDM makes use of an oversized range of closely spaced orthogonal sub-carriers that area unit transmitted in parallel. Each sub-carrier is modulated with a traditional digital modulation theme (such as QPSK, 16QAM, etc.) at a lower image rate.

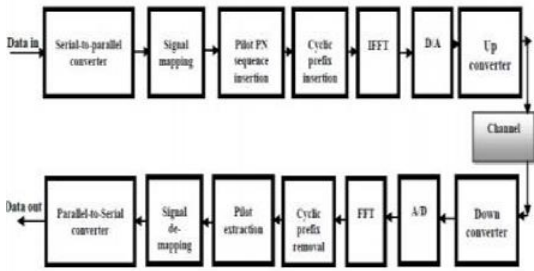

Fig2. Block Diagram of OFDM

III. MOTIVATIONS AND CHALLENGES

The first one is that the estimation of the channel state data and therefore the effects of the estimation error on the system performance. The second subject elaborate is that the attainable sub-channel correlation between the transmit and receive antenna pairs and therefore the performance analysis with the presence of correlation. To find the orthogonality between the signals, spatial multiplexing, data rate and bit error rate exploitation totally different antenna configurations and additionally with different modulation techniques.

IV. PERFORMANCE ANALYSIS

A. BIT ERROR RATE (BER): The BER is calculated by comparison the transmitted sequence of bits to the received bits and count the amount of errors. The magnitude relation of what proportion bits received in error over the quantity of total bits received is that the BER. BER may be a unit less amount, usually expressed as a proportion or ten to the negative power. The BER of SISO-OFDM systems impaired by frequency offset is analyzed in, within which the frequency offset is assumed to be utterly glorious at the receiver, and, supported the lay to rest carrier interference (ICI) analysis, the BER is evaluated for multipath weakening channels. Several frequency offset estimators are projected.

$$BER = \text{number of errors} / \text{total number of bits sent}$$

B. CHANNEL CAPACITY: The channel capability C , is outlined to be the utmost rate at that info is transmitted through a channel. The data rate, C , is outlined to be the most rate at that data are often transmitted through a channel. A given

communication system incorporates a most rate of knowledge C called the data rate. If the data rate R is a smaller amount than C , then one will approach at random little error possibilities by exploitation intelligent writing techniques. to induce lower error possibilities, the encoder must work on longer blocks of signal knowledge. This entails longer delays and better process needs. Thus, if $R \leq C$ then transmission is also accomplished while not error within the presence of noise. Sadly, Shannon’s theorem isn’t a constructive proof — it simply states that such a writing methodology exists. The proof will thus not be accustomed develop a writing methodology that reaches the data rate. The negation of this theorem is additionally true: if $R > C$, then errors can not be avoided notwithstanding the writing technique used.

$$C = \text{Blog}(1+S/N)$$

C. SPATIAL MULTIPLEXING: Spatial multiplexing has been usually used to increase the MIMO link capacity by transmitting independent data streams in the same frequency band and time slot. It can transmit antenna at the same time, and differentiate multiple data streams at the receiver of propagation path using channel information. Spatial multiplexing could be a MIMO wireless protocol that sends separate data signals or streams between antennae to reinforce wireless signal performance or functionality. It’s a kind of “spatial diversity” and an engineering trick that helps to extend the probabilities for various styles of end-to-end transmission. In spatial multiplexing, multipath propagation involves multiple-input/multiple-output or MIMO wireless technology setups – the transmit stations use multiple transmit and receive antennas to provide sophisticated signal results. A wireless access point uses multiple radios to enable quite one unique data stream to travel between the transmitter and receiver. This increases throughput and could be a common technique so as to innovate with wireless setups.

D. FADING: The "flatness" perceived by a narrow-band channel overcomes the frequency selective attenuation. The attraction of OFDM is especially as a result of its manner of handling the multipath interference at the receiver. Multipath development generates 2 effects (a) Frequency selective weakening (b) Inter symbol interference (ISI). Fast fading occurs if the channel impulse response changes rapidly within

the symbol duration. In other words, fast fading occurs when the coherence time of the channel TD is smaller than the symbol period.

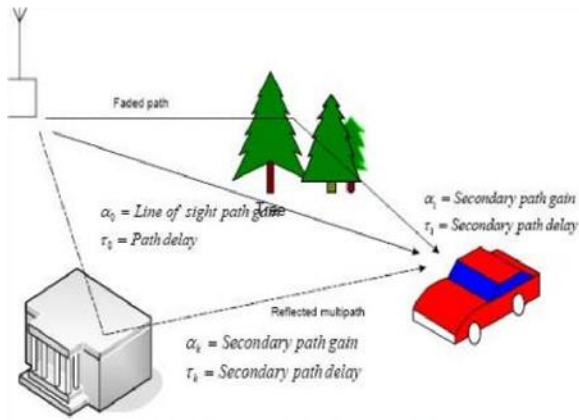

Fig. 5. Fading in multipath propagation.

E. ORTHOGONALITY: The main concept in OFDM is orthogonality of the sub carriers. It's possible to rearrange the carriers in an OFDM Signal so the sidebands of the individual carriers overlap.

Signals can still be received without adjacent carriers' interference. The "orthogonal" a part of the OFDM name indicates that there's an exact mathematical relationship between the frequencies of the carriers within the system. The orthogonality also allows high spectral efficiency, with an entire symbol rate near the sampling rate for the equivalent baseband signal (i.e., near half the rate for the double-side band physical pass band signal). Almost the complete available waveband is used.

V. WORKING

MIMO signaling can improve wireless communication system in two ways such as diversity methods and spatial multiplexing. Diversity methods improve the robustness of the communication system in terms of BER by exploiting the multiple paths between transmit and receive antennas.

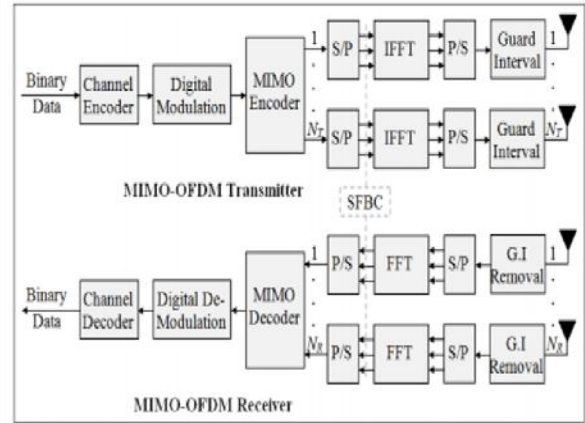

Fig 3. Block Diagram of MIMO-OFDM

The input serial binary knowledge going to be processed by a knowledge scrambler initial and so channel coding is applied to the input file to boost the BER (bit error rate) performance of the system. The encoded knowledge stream is any interleaved to cut back the burst image error rate. Smitten by the channel condition like weakening, totally different base modulation modes like BPSK (binary part shift keying), QPSK (quadrature part shift keying) and QAM area unit adaptively to boost the information rate. The modulation mode may be modified even throughout the transmission of information frames.

VI. RESULTS

Here the simulation results in conjunction with higher than mentioned parameters taken for simulation at given victimisation MATLAB version 14b. The image error rate performance of QAM and m-ary PSK modulation technique utilized in MIMO OFDM transmission theme. The channel is determined as flat with none multipath delays. QAM modulation technique is taken into account as hybrid modulation theme ar distinguished in amplitude moreover as in part. The BER performance of 2x2 vs 4x4 vs 8x8 MIMO system. Here we've used 16QAM modulation theme to calculate the BER performance. we are able to observe here that as we tend to maintain increasing range of transmission antenna moreover as number of receiving antennas we are going to get well BER and therefore the SNR price is additionally decreasing. During this figure eight x eight MIMO system has the higher BER in lower SNR.

On increasing the quantity of antennas, the SNR of the system will increase hand in hand that refers to the rise in capability of the MIMO system. to extend capability and keeping information measure and sending power same is currently a well-accepted reality by simply golf stroke additional antennas at the transmission and reception aspect.

In associate degree OFDM-based MIMO system, spatial multiplexing is performed by transmittal freelance knowledge streams on a tone-by-tone basis with the full transmit power split uniformly across antennas and tones. Though the utilization of OFDM eliminates Inter-Services Intelligence, the process complexity of MIMO-OFDM spatial-multiplexing receivers will still be high.

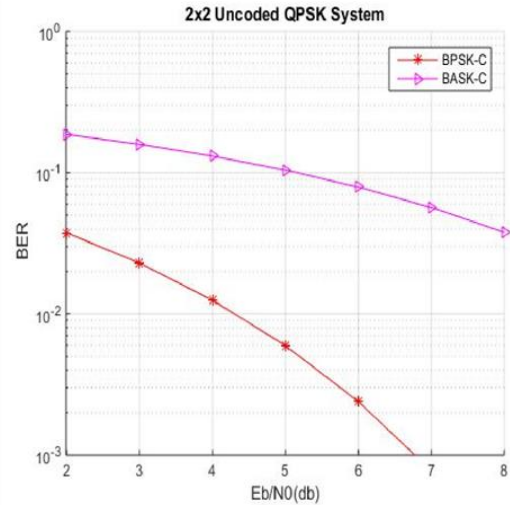

Fig 6 Spatial Multiplexing

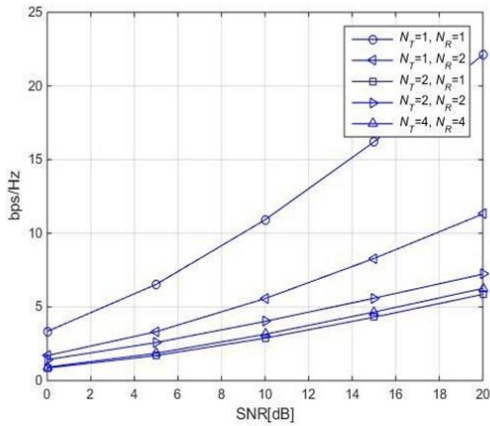

Fig 4 Channel Capacity

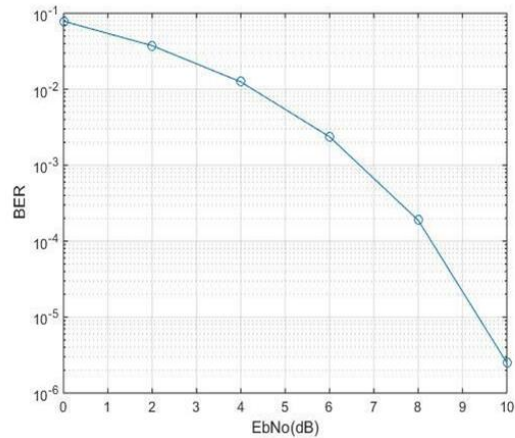

Fig 7 BER for QPSK

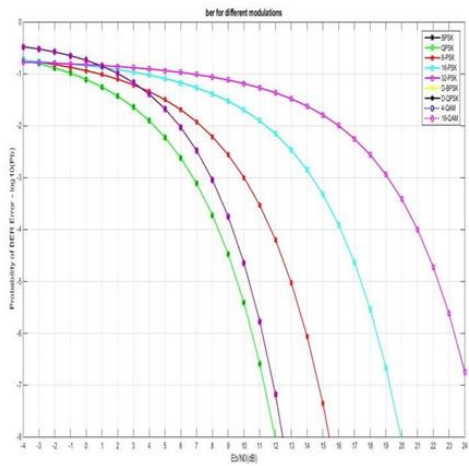

Fig 5 BER for BPSK, QPSK, QAM

CONCLUSION

The experiment results show that just in case of a channel the system has sensible BER performance once there ar additional antennas at each transmitter also as receiver, particularly if the quantity of the receiving antennas is bigger than that of the transmission antennas. However, if the quantity of transmission and receiving antennas is same then the system provides higher performance. As an extra extension we will additionally use the RS-CC cryptography, Turbo cryptography and LDPC cryptography to boost the BER performance. The fundamental ideas of a MIMO-OFDM system with relevant style and performance parameters in theoretical & sensible are studied. The generalized diagram of a basic MIMO-OFDM system which has

variety of transmission and receiving antennas at the each ends to maximize information rates and potency of the system has been explained briefly. Further, the BER is reduced and performance analysis of MIMO-OFDM systems with BPSK modulation has been coated during this thesis.

Future work will be done on this technique, by combining OFDM and STBC for MIMO, OFDM detector and channel effects with totally different noise models will be simulated. There may well be several experiments performed considering this approach in numerous atmospheres inside and out door, to form system reconciling and develop feedback approach.

ACKNOWLEDGMENT

Without the guidance and motivation of many people who are having troubles in the day-to-day life, this project could not achieve as it did. In this many people are our advisors, our faculty of Electronics and Communication Engineering department at Vasireddy Venkatadri Institute of Technology and our fellow students. This project would not exist without the moral support of our guide Ms. R. Tejaswini (Asst.Professor). With the help of our Electronics and Communication Department, we would not have resources to complete this project.

REFERENCES

- [1] Arun Agarwal and Saurabh N. Mehta, "Combined Effect of Block interleaving and FEC on BER Performance of OFDM based WiMAX (IEEE 802.16d) System", American Journal of Electrical and Electronic Engineering © Science and Education Publishing USA, vol. 3, no. 1, pp. 4-12, March 2015.
- [2] Arun Agarwal and Kabita Agarwal, "Implementation and Performance Evaluation of OFDM System in Diverse Transmission Channel Using Simulink", American Journal of Electrical and Electronic Engineering, vol. 3, no. 5, pp. 117-123, 2015.
- [3] Nimay Ch. Giri, Rupanita Das and SK Mohammed Ali, "BER Analysis And Performance Of Mimo-ofdm System Using BPSK Modulation Scheme For Next Generation Communication Systems, " International Journal of Engineering Sciences & Research Technology (IJESRT), Vol. 3, Issue 3, pp. 1622-1629, March 2014.
- [4] Yashvant Dhiwar and Rakesh Mandal, "Performance Analysis of Various Equalizers for ISI reduction in MIMO-OFDM System," International Journal of Research in Advent Technology (IJRAT), vol. 2, no. 3, pp. 1620, March. 2014.
- [5] Sabita Gauni and Kumar Ramamoorthy, "Analysis of Reduction in Complexity of MIMO-OFDM Systems with Frequency Offset Estimation and correction," Journal of Computer Science (JCS), Vol. 10, No.2, pp.198209, 2014.
- [6] Betsy Jose and Mr. B. Satish Kumar, "Design of MIMO-OFDM SDM Systems for High-Speed Data Transmission," International Journal of Information & Computation Technology (IJICT), Vol. 4, No. 1, pp. 1-8, 2014.
- [7] H. Ajra, Md. Zahid Hasan, and Md. Shohidul Islam, "BER Analysis of Various Channel Equalization Schemes of a QOSTBC Encoded OFDM based MIMO CDMA System, "International Journal Computer Network and Information Security (IJCNIS), Vol.3, No.4, pp.30-36, 2014.
- [8] Mr. Atul Subgh Kushwah, "Performance Analysis of 2*4 MIMO-MC-CDMA in Rayleigh Fading Channel
- [9] ZF-decoder," International Journal of Engineering Trends and Technology (IJETT), Vol. 8, Issue 4, pp. 1-4, Feb. 2014.
- [10] Mr. Sivanagaraju and Dr. Siddaiah," Comprehensive Analysis of BER and SNR in OFDM Systems,
- [11] "International Journal of Innovative Research in Computer and Communication Engineering (IJRCCE), Vol. 2, Issue 2, pp. 3059- 3065, Feb. 2014.

- [15] N. Achra, G. Mathur, and R.P. Yadav,” Performance Analysis of MIMO-OFDM System for Different
- [16] Modulation Schemes under Various Fading Channels, “International Journal of Advanced Research in Computer and Communication Engineering (IJARCCE), Vol. 2, Issue 5, pp. 2098-2103, May. 2013.
- [17] M. Divya, “BER performance of BPSK modulation and OFDM-BPSK with Rayleigh multipath channel,” IJEAT, vol. 2, Issue 4, pp. 623-626, April. 2013.
- [18] P. Wadhwa and G. Gupta, “BER Analysis & Comparison of Different Equalization Techniques for MIMOOFDM System,” International Journal of Advanced Research in Computer Science and Software Engineering (IJARCSE), Vol. 3, Issue 6, pp. 1682-1688, June 2013.
- [19] N. Sood, A.K. Sharma, and M. Uddin, “BER Performance of OFDM-BPSK and QPSK Over Generalized Gamma Fading Channel,” International Journal of Computer Applications (IJCA), Vol. 3, No. 6, pp. 13-16, June 2010.
- [20] Z. Iqbal and S. Nooshabadi, “Effects of channel coding and interleaving in MIMO-OFDM systems,” IEEE Int. Midwest Sym. on Cir. and Sys. (MWSCAS), Seoul, Korea, pp. 1–4, August 2011.