

A Review on Fishing Gear Technology of The World and Its Application

OKWUOSA, OBINNA B.^{1,2}, EYO, JOSEPH E.², OMOVWOHWOVIE EMMANUEL E.³, AMADI-IBIAM, CHRISTINA O.⁴

¹ Department of Science Laboratory Technology, Akanu Ibiyam Federal Polytechnic, Unwana.

² Department of Zoology and Environmental Science, University of Nigeria, Nsukka

³ Department of Fisheries Technology Federal Polytechnic Ekowe Bayelsa State, Nigeria.

⁴ Department of Fisheries and Aquaculture, Ebonyi State University, Nigeria

Abstract- Fishing gear are equipment or devices used for fishing. Fishing gears vary greatly in their structure, materials used and principles of capture process and methods of operation. Traps are impounding devices into which an organism is lured either for food or shelter and are unable to escape. There are a wide number of fishing gears devices constructed using diverse technologies and methods use in operating them. These gears have been broadly classified as per the FAO classification of fishing gears. Fishing gears are of various shapes, designs and sizes depending on the area of operation and the behaviour of target fishes and are mostly made up of various materials. The choice of fishing gear, principal mechanism of capture fish, and gear designing techniques was discussed. They major categories of fishing gears technologies which includes active gear, passive gear and miscellaneous, unorthodox and obnoxious methods/practices was discussed. The methodology of the use of these fishing gears, their description, possible effects both positive and negative on the water body and the environment was discussed. Furthermore, new innovations (mechanization) to improve the efficiency of gears and thus the fishery are addressed in the light of rapid socioeconomic changes within the fishery industry. Illustrative figures on fishing gear technology and fishing methods were shown and discussed. From experience with fishing gear and literatures on the subject, there has been a continuum in development of fishing gears, with evolution resulting from modernization factors. The adaptation of new technologies could help small scale fisheries increase their catch, but the introduction of any new fishing technology always demands good rational management and regulation.

Vessels must also march with new fishing methods and gear. As gears become more complex, it may require updating of vessels in size, power and design. A basic understanding of the properties, function and operation of the major fishing gears and methods is therefore fundamental hence recommended for decision making in fisheries management, particularly when it comes to technical measures in fisheries regulations.

Indexed Terms- Fishing gear, active gear, passive gear

I. INTRODUCTION

Fishing gears vary greatly in their structure, materials used and principles of capture process and methods of operation. Fishermen may use several fishing gears and methods appropriate for the species and environmental and ground conditions. Fishing is an act of harvesting fish and equipment or devices used for fishing are called 'fishing Gears'. Fishing gear can be described as any kind of equipment used in harvesting, cropping or capturing fish from any water body. Fishing gears are the tool or implement or equipment used in capturing fish from any water body such as traps, hooks and lines, gill nets, trawls, seine nets, lift nets, clap nets, spears, cast nets, entangling nets, drift nets etc. (Nuhu and Yaro, 2005; Tagago *et al.*, 2011; Davies and Kwen, 2012) while fishing method is how the gear is used.

According to (Moses, 1992) fishing gear has generally undergone a lot of modifications and improvements in consonance with advances in modern technology. The types, designs and mode of operations of the

traditional and modern fishing gear employed in the inland and coastal waters of Nigeria have been fairly described (Udolisia *et al.*, 1994). Due to different habits and habitats of the arrays of fish species in a particular water body, different gears are also being used for capturing fish (Tagago *et al.*, 2011).

Seasonal changes in species diversity and abundance have given ways to the invention of different fishing gear annually (Bankole *et al.*, 2003). Fishing methods have continuously evolved throughout recorded history. Fishers are inventive and not afraid of trying new ideas. The opportunities for innovation have been especially good in recent decades with advances in fibre technology, mechanization of gear handling, improved performances of vessels and motorization, computer processing for gear design, navigation aids, and fish detection to mention only a few technologies (Moore and Jennings, 2000).

This paper will describe some of the traditional and modern fishing gear technology and fishing methods employed around the world. Their advantage as well as disadvantages shall be given adequate consideration. From experience with fishing gear and literatures on the subject, there has been a continuum in development of fishing gears, with evolution resulting from modernization factors. The adaptation of new technologies could help small scale fisheries increase their catch, but the introduction of any new fishing technology always demands good rational management and regulation. Vessels must also march with new fishing methods and gear. As gears become more complex, it may require updating of vessels in size, power and design.

II. THE IDEAL FISHING GEAR

Some criteria for the ideal fishing gear could be:

- highly selective for the target species and sizes, with negligible direct or indirect impact on nontarget species, sizes and habitats;
- effective, giving high catches of target species at lowest possible cost;
- quality orientated, producing catches of high quality.

According to these and additional criteria that could be added to the list, it can easily be stated that the ideal

fishing gear does not exist, as no fishing gear fulfils the complete list of desired criteria and properties. However, in the process of moving towards sustainable fisheries management, different fishing gears with their specific properties and potential for improvement are an important compartment in the “fisheries manager’s toolbox”. A basic understanding of the properties, function and operation of the major fishing gears and methods is therefore fundamental for decision making in fisheries management, particularly when it comes to technical measures in fisheries regulations.

III. CLASSIFICATION OF FISHING GEAR

Various methods to catch fish and other aquatic resources, with or without a gear, have always been practiced in Nigeria and in the world at large. A fishing gear is the tool with which aquatic resources are captured, whereas the fishing method is how the gear is used as mentioned earlier. Gear also includes harvesting organisms when no particular gear (tool) or boat is involved.

Furthermore, the same fishing gear can be used in different ways by different fishers. A common way to classify fishing gears and methods is based on the principles of how the fishes or other preys are captured and, to a lesser extent, on the gear construction or gear materials used (Nedelec and Prado, 1990). There are many different types of fishing gear. Some gear has been adapted to certain species on the basis of the species’ special characteristics such as their behaviour, their feeding and spawning migration patterns. Changes in fishery activities throughout the year are due to biological and climatic conditions. Active fishing methods have been employed ever since the Stone Age and have developed over the ages to give us the wide variety of fishing gear we have today.

Table 1: Classification of Fishing Gears by Brandt (in Boopendranath, 2009)

Gears	Types
Nets	Set Nets (Gill Net, Trammel Net, Drift Net) Surrounding Net (Beach Seine)

	Throw Net (Cast Net) Hand Net (Scoop Net) Lift Net (Attala) Clap Net (Single & Twin Clap Net)
Traps	Trigger Traps Non-Return Valve Trap Ita Trap Spring Loaded Trap Circular Traps Bamboo Traps
Brush Parks	Iken Acadja
Wounding Gears	Cutlass Spear
Posions and Explosives	Dynamite Derris Plant Gamalin 20
Hooks and Lines	Spring Loaded Hook Long Lining
Electric Fishing	Electricity (Dc /Ac.Current)

IV. CHOICE OF FISHING GEAR

Choice of fishing gear primarily depends on biological, behavioral and distribution characteristics of the target species and fishing environment (Table 2). There is no universal fishing gear suitable for all fishing conditions and resources. Fishing gear has to be selected or designed based on the presence of maximum number of attributes suitable for the particular fishing condition and resource and trade-offs may be necessary.

Table 2: Choice of fishing gear based on biological, behavioral and distribution characteristics of the target species.

Target fish group	Choice of fishing gear
Demersal, large feeding fish with sparse, scattered distribution	Bottom set line, bottom vertical long lines, bottom gill nets, hand lines, traps, bottom trawls.
Demersal small sized fishes	Gill nets, traps, bottom trawls
Pelagic, large sized with sparse and scattered distribution	Drift long lines, vertical long lines, gill nets, midwater trawls

Pelagic, small and medium sized schooling fishes	Purse seines, midwater trawls, hand line
Pelagic predatory fishes	Troll lines, long lines
Light-attracted fishes and cephalopods	Light-assisted dip nets and purse seines, jigging.
Fish concentrated by FADs	Purse seines, hand lines, gill nets

Source: Hameed and Boopendranath (2000)

V. FISHING GEAR PRINCIPAL MECHANISMS, DESIGN AND MODELING TEST

Fishing gears have generally evolved on a trial and error basis and until recently, only empirical approaches have been used to determine design parameters rather than analytical procedures. Design and development efforts based fish behavior, engineering studies, system analysis and model studies taking into consideration resource conservation, ecological and economic issues have been taking place in the recent decades. With the development and wider availability of synthetic gear materials, recent advances in vessel technology, navigational electronics, gear handling machinery, fish detection methods and fish behavior studies, large- scale changes have taken place in the design, fabrication, operation and catching capacity of modern fishing.

VI. PRINCIPAL MECHANISMS OF FISH CAPTURE

Principal mechanisms used in fish capture are

- i. Filtering e.g. trawls, seines and traps;
- ii. Tangling e.g. gill nets, entangling nets are trammel nets;
- iii. Hooking, e.g. hand line, long line and jigging;
- iv. Trapping, e.g. pots and pound nets;
- v. Pumping, e.g. fish pumps.

Main behavior controls used in the fish capture process are:

- i. Attraction e.g. bait, light, shelter;
- ii. Repulsion or avoidance reaction, e.g. herding or guiding by netting panels as in set nets and trawls

or sweeps and wires as in boat seines and trawls (Hameed and Boopendranath, 2000).

VII. FISHING GEAR DESIGN

Design process involves a divergent phase when analysis of the situation, statement of needs, specification, standards of operation and constraints are spelt out; a transformational phase which includes generation of design ideas; and a convergence phase during which an evaluation in terms of objectives of design, utility and economic viability, prototype development, testing and evaluation takes place (Fig.1). A preliminary design thus generated is further refined based on additional information through an iterative cycle until final design is adopted.

VIII. MODEL TESTING

Model testing is increasingly used for design evaluation of the existing commercial fishing gear designs with a view to optimize their design parameters and for development of newer designs. In model testing, a scaled down model of the fishing gear is tested in a flume tank in order to study its behavior and estimate working parameters. Principles of similarity are then used to assess the dimensions, specifications and characteristics of the full-scale version based on model studies. The fishing gears are further evaluated using full-scale version through statistically designed comparative field trials with a gear of known fishing efficiency and operational parameters are verified through gear monitoring instrumentation and underwater observations.

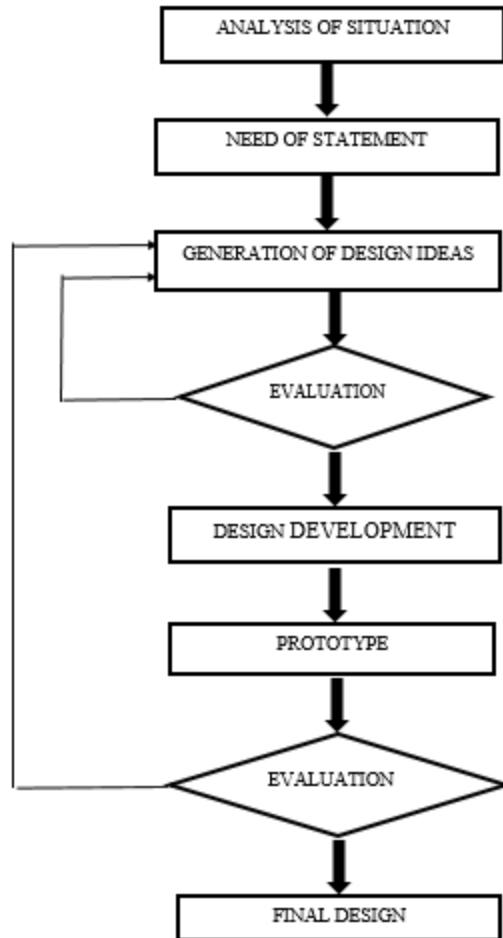

Figure 1: Design process

IX. FACTORS AFFECTING FISHING GEAR DESIGN

Hameed and Boopendranath (2000) have reviewed the factors influencing fishing gear design. Important factors which influence the design of fishing are

- i. biology, behavior and distribution of target species;
- ii. fishing depth, current and viability;
- iii. sea bottom conditions, size and engine power of fishing, vessel, energy conservation objectives, selectivity and resource conservation objectives.

X. BIOLOGY, BEHAVIOR AND DISTRIBUTION OF TARGET SPECIES

Design of fishing gear is greatly influenced by biological characteristics such as body size and shape, feeding habits and swimming speed; behavior in the vicinity of fishing gear and during capture process;

spatial distribution and aggregation behavior of the target species.

Body size and shape determine the mesh size required to enmesh and hold the fish in gill nets and the mesh size to retain the target size groups of the species without gilling in the trawls, seines and traps. Body size is also related to the tensile strength requirements for the netting twine in gill nets and hook size and lines in hook and lines. Body size is again directly proportional to the swimming speed (Hameed and Boopendranath, 2000) which is a significant attribute to be considered in the fishing success of dragged gear. Feeding habit of the target species is more important in passive fishing methods like hook and line and traps where the fish is attracted by the bait, and in the active fishing methods like troll line used for catching predatory fishes.

Consideration of the swimming speed of the target species is more important particularly in the active fishing methods like trawling, seining and trolling. Fishes are known to sustain a cruising speed of 3-4 body lengths per second for short duration. During burst speeds reserve energy supplies in the fish muscle is used up. Fish in front trawl mouth will be eventually caught if the trawling speed is greater than the cruising speed of the fish. Behavioral differences between fish and crustaceans and size differences between them, could be used in the design of selective trawl designs. Catching efficiency is maximized when the vertical opening of the trawl mouth, vertical dimension in gill nets, and the catenary of the main line of the long line with branch of lines and hooks, coincide with the vertical range of the layer of maximum fish abundance. Hence knowledge of the vertical distribution of the target species could be used to optimize the horizontal and vertical dimensions of the netting panels in gill nets, main line catenary in long line and mouth configuration in trawls.

XI. FISHING DEPTHS, CURRENT AND VIABILITY

Hydro-acoustic pressure increases approximately at the rate of one-unit atmospheric pressure (1 bar) for every 10m depth. Buoyancy elements used in the deep sea fishing gear such as deep sea trawls, gill nets and bottom vertical lines have to be strong enough to

withstand the high pressure at the fishing depth. Prevailing strong currents in the fishing grounds may restrict the choice of fishing gears to longlines and gillnets which are less affected by currents. Light levels at the fishing depth could influence the fishing success, as vision of fish is affected by light levels. In passive fishing gears such as gillnets, visibility of netting panel adversely affects fishing efficiency, visibility is again negatively indicated in hook and line operation while in light-assisted jigging-controlled light plays an important part. Visibility is also important in effective herding during the capture process in trawls and in large pound nets and trapping enclosures where leader nets are used.

XII. SEA BOTTOM CONDITIONS

Rough sea bottom conditions limits the operation of most of the fishing gears close to the ground except handlines, vertical longlines, bottom vertical longlines and traps. Trawling on rough bottom requires special rigging such as bobbin rig on rock hopper rig, improvements in trawl design to minimize gear damage or loss and selection of appropriate otter boards.

XIII. OTHER FACTORS

Design features of fishing gears will also be influenced by the scale of operations, size and engine power of fishing vessel, energy conservation objectives, selectivity and resource conservation objectives, catch volume requirements, operational and handling requirements of the gear, prevailing weather conditions, skill required for fabrication, maintenance and operation, material availability, local traditions and economic considerations.

Major categories of fishing gears which shall be explained in the subsequent sections are categorized as:

- Passive,
- Active,
- Miscellaneous,
- Unorthodox and Obnoxious fishing gears practices

XIV. PASSIVE FISHING GEAR TECHNOLOGY

Passive gears are stationary gears. It does not have to be dragged, pulled or towed to capture fish.

Hook and lines, traps, wires, gill nets among others affectively fish by themselves. The catch is recovered by simply removing the gear from the water after a time period. No energy is expended on towing, pulling or dragging of gear (Eyo and Akpati, 1995; Dienne and Olopade, 2017). With passive gears, the capture of fish is generally based on movement of the target species towards the gear examples are: traps, Set hooks, Gill net, Drift net while with active gears capture is generally based on an aimed chase of the target species example are: Cast net, Beach Seine, Hand net, Clap net Lift net and trawls. Hook and lines, traps, wires, gill nets among others affectively fish by themselves. A parallel on land would be the difference between the trapping of and hunting for animals (Dienne and Olopade, 2017).

Passive gears are in general the most ancient type of fishing gears. These gears are most suitable for small scale-fishing and are, therefore, often the gear types used in artisanal fisheries. Some passive fishing gears are often referred to as "stationary" fishing gears. Stationary gears are those anchored to the seabed and they constitute a large group of the passive gears. However, some moving gears such as drift nets may also be classified as passive gears, as fish capture by these gears also depend on movement of the target species towards the gear (Brandt and Lokkeborg, 1996). Passive gears are categorized into Nets, Hook and line fishing, Pots and traps etc.

• Hooks and Lines

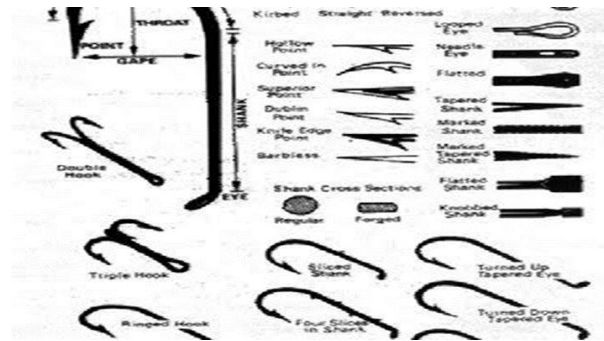

Figure 2: Hook types employed in hook gear fisheries (Eyo and Akpati, 1995)

This is the simplest gear employed for fishing. The size of the hook used depends on the type of fish. Hooks have numbers. Hooks used for tilapia are from numbers eleven to sixteen. Those for Nile perch are

from seven to ten. Lung fish are fished with hooks of numbers six and five (Dienne and Olopade, 2017).

• Hooks and Lines Techniques

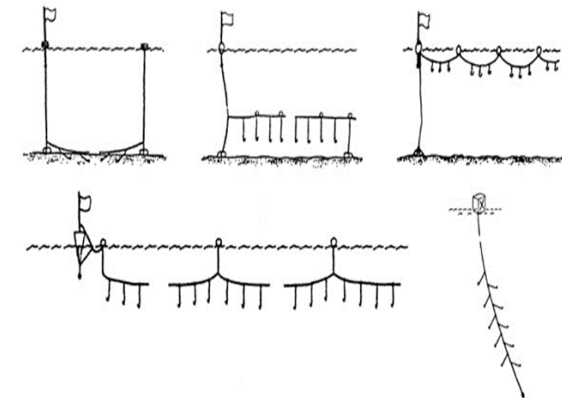

Figure 3: Hooks and Lines fishing gears

The longline fishing following main operations:

- Baiting (threading a piece of bait on each hook),
 - Setting,
 - Fishing ("soaking" the line for some hours),
 - Retrieval,
 - Removal of fish and old bait,
 - Gear maintenance, Baiting, etc
- (Eyo and Akpati, 1995; Dienne and Olopade, 2017)

• Headlining

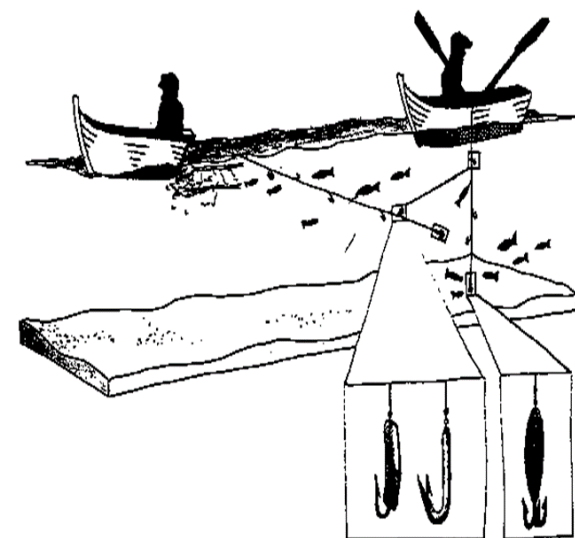

Figure 4: Catching principle and construction of trolling (left) and jigging (right). Expanded view: examples of lures and jig (Dienne and Olopade, 2017).

- The gear is simple: a nylon monofilament is commonly used as line with one to several hooks at the end with bait or lures.
- In handlining the fishing line is vertical and is operated from a drifting or anchored vessel.
- Handlining is also conducted from the shore, with and without the use of a pole.
- From using only a single line, the operation can be scaled up by using several lines on larger vessels. In recent years jigging has become mechanized and automated by the development of jigging machines (Dienye and Olopade, 2017).

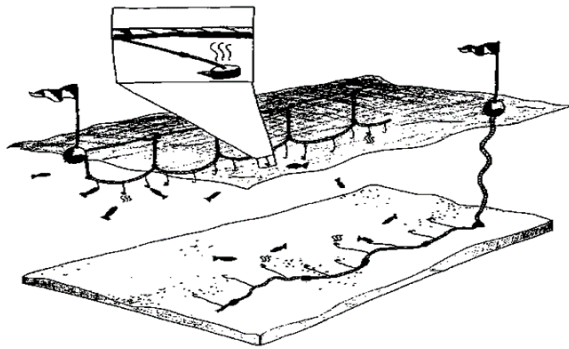

Figure 5: Catching principle and construction of longline

- Longlining is based on attracting fish by bait attached to the hook.
- Longlining exploits the chemical sense of the fish.
- Odour released from the bait triggers the fish to swim towards and ingest the baited hook with a high probability of being caught (Bjordal and Lokkebond, 1996).
- Set Longlines

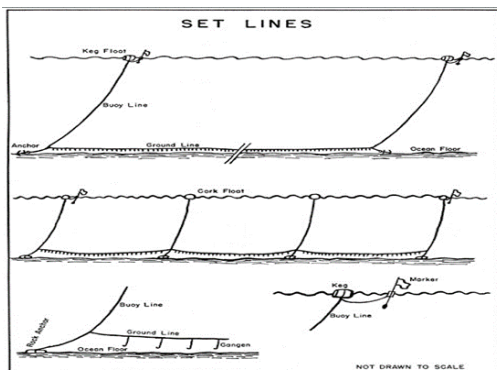

Figure 6: Illustrating two of the many forms of set lines

- A set longline consists of a mainline and snoods with baited (occasionally unbaited) hooks at regular intervals.
- The number of hooks, distance of snoods on the main line and length of the snoods depends on the target species, the handling capacity and technology used.
- Longlines can be set as bottom lines (including on very rough bottom and/or coral reefs) or, less commonly, in midwater or even not far from the surface (Eyo and Akpati, 1995).
- Its length can range from few hundred meters in coastal fisheries to more than 50 km in large scale mechanized fisheries.
- Other types of Long lines

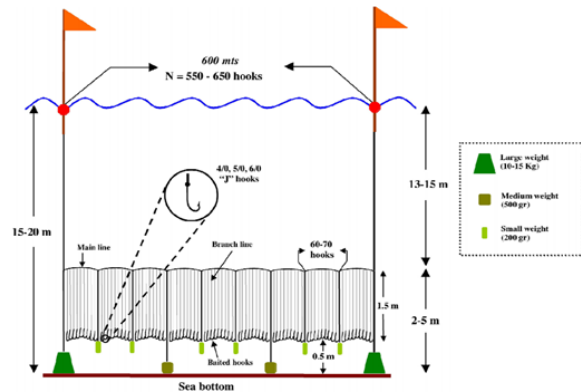

Figure 7a: Illustration of long line gear

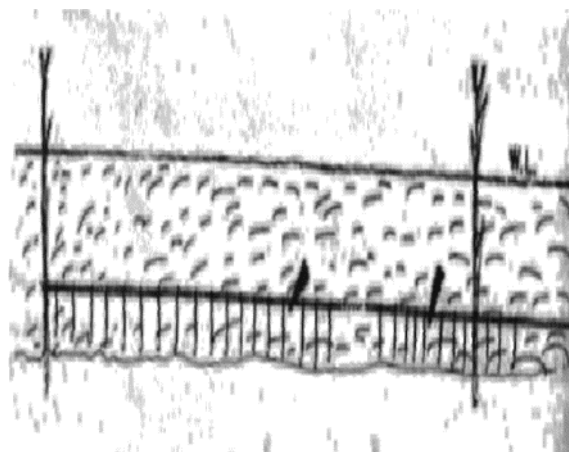

Figure 7b: Mari-mari [foul-hook long line] (Eyo and Akpati, 1995)

• Angling Gear

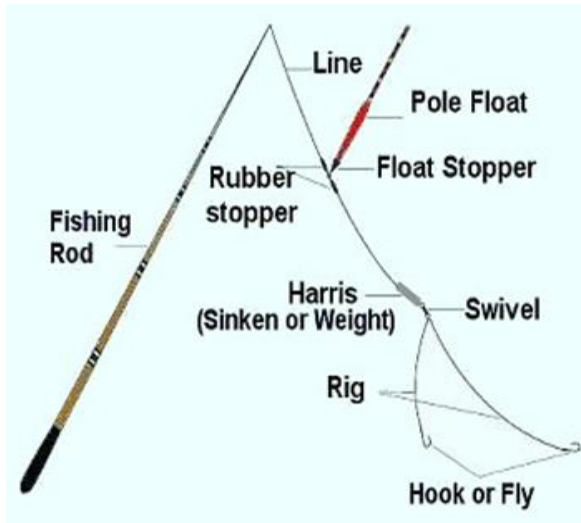

Figure 8: Illustration of angling gear usage (Badapanda, 2013)

- The simplest and cheapest gear
- Is manually operated by one person along the lake beaches or on the riverbanks.
- Effective angling is done in calm waters early in the morning or evening or on dark nights.
- (Badapanda, 2013)

Maze Gear

- Consist of equipment for leading fish into a situation or enclosure from which they cannot escape or from which the avenue of escape is not readily apparent.
- Maze gear includes many varieties of fishing pots, fyke nets, trap, pound nets and tidal weirs among

other modifications (Eyo and Akpati, 1995; Meenakumari *et al.*, 2009).

Pot Gear

- A pot is designed in the form of cages or baskets, small or large (with dimensions ranging from around half a meter to two).
- It is made from various materials (wood, wicker, metal rods, wire netting, plastic etc.).
- Pots usually take the form of a rectangular box or a vertical, flattish cylinder or a horizontal half cylinder, the flat side being on the sea bed.
- They might have one or more openings or entrances.
- Most of the pots are set on the bottom, while a few models are designed to be in mid-water.
- Pots are used with or without bait, depending on the target species.
- Pots are hauled either by hand (if the depth is not too large and if there are only a few pots to be retrieved) or with a pot hauler or line coilers (for deep water fishing or hauling a series of pots).
- They are usually set singly or in rows.
- That can be subdivided into: Cylindrical shape pot, Splendid shape pot and Box trap pot

• Cylindrical Shape Pot

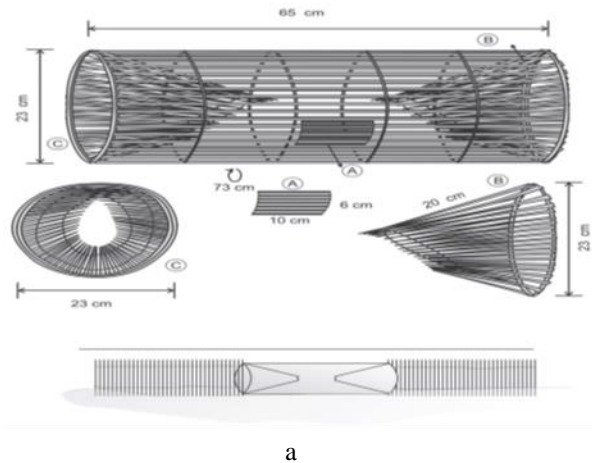

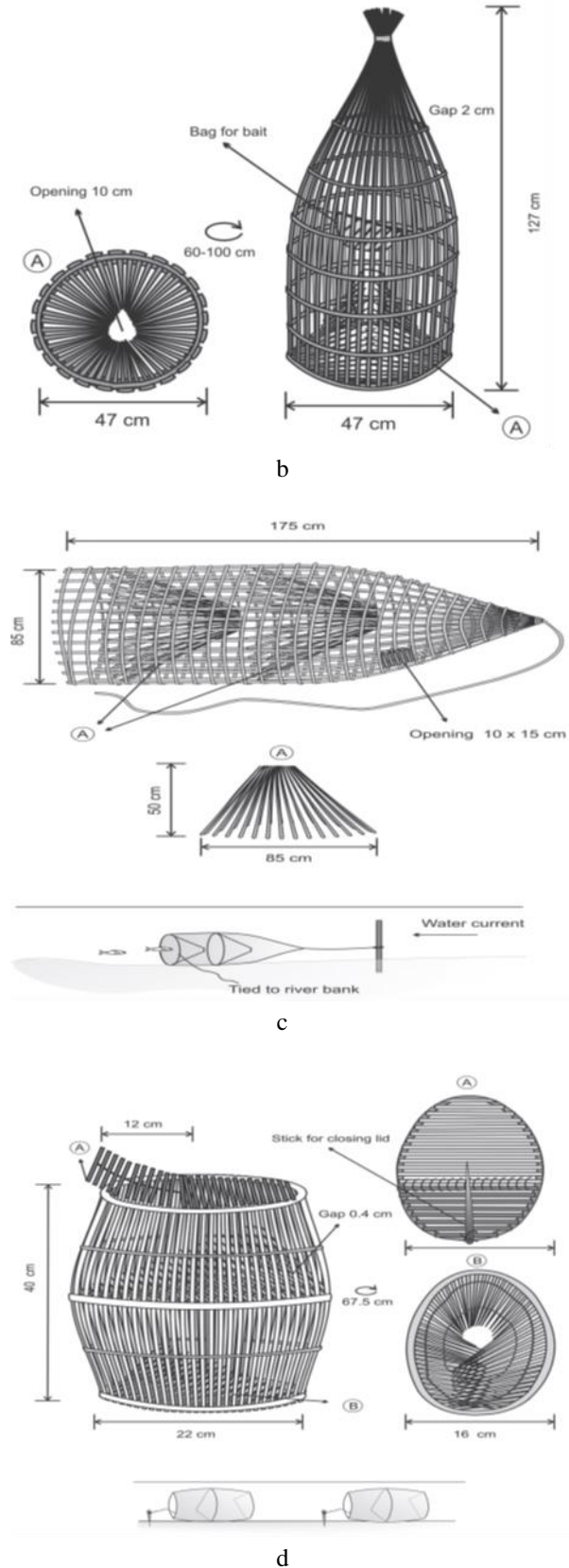

Figure 9a-d: Cylindrical pot (Source: Pravin *et al.*, 2011)

• Spindle Shaped Pot

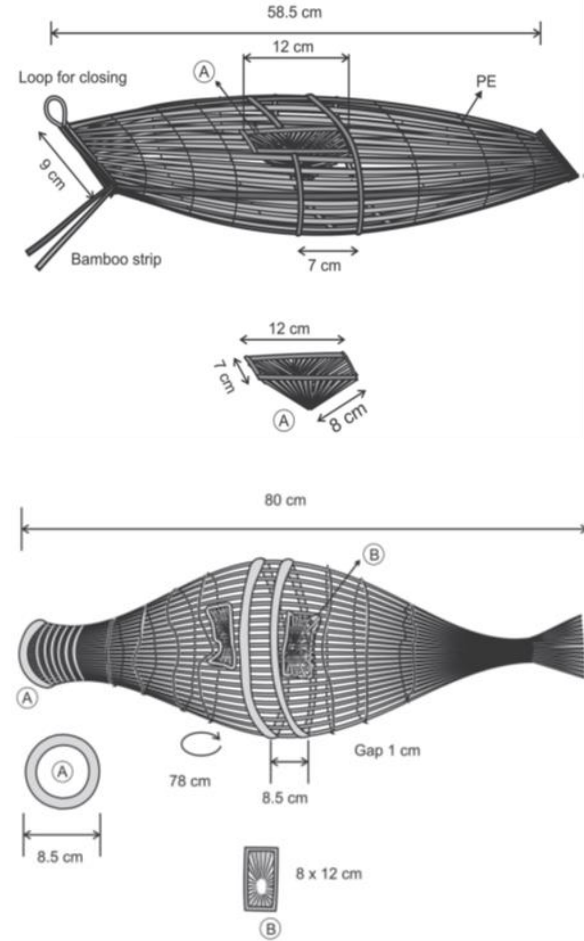

Figure 9a-b: Spindle pots Source: Pravin *et al.*, 2011

• Traps

Traps are usually bigger than pots, although the word trap may be used for pots as just described. However, traps (and similar structures called barriers, fences, weirs, corrals etc.) are usually large, elaborate nets or wooden structures often fixed to the sea bed, particularly in shallow or inshore sites, where the top of the structure extends above the water surface, and placed taking into account the behaviour (especially local tidal migrations) of the target species (Cook *et al.*, 2000). The fish are induced to enter the trap through an entrance that likewise diminishes in size towards the interior of the trap. Since the depth of the trap may be several metres and allow some fish the

possibility of finding their way out, two or three such entrances may be arranged in sequence, occasionally with fairly elaborate "cul-de-sacs" to one side or the other or both (Mohanrajan, 1993).

Box Trap

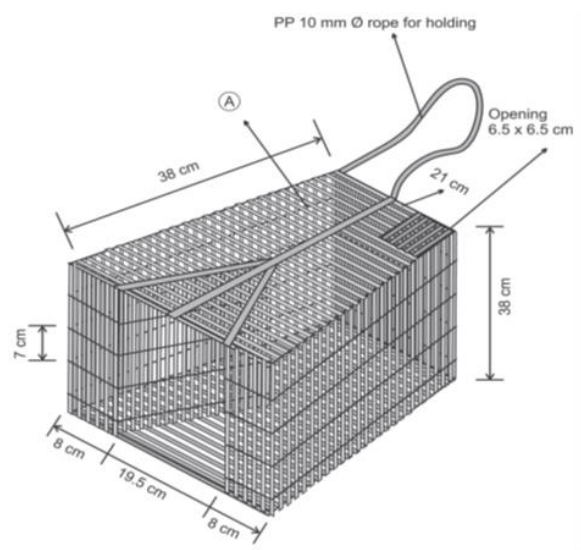
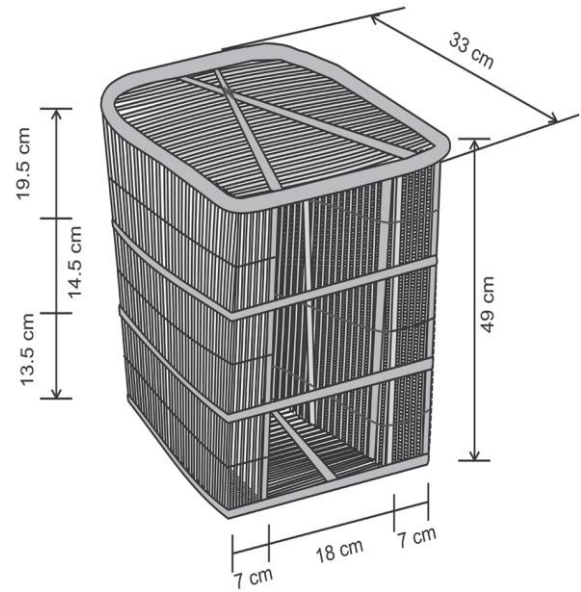
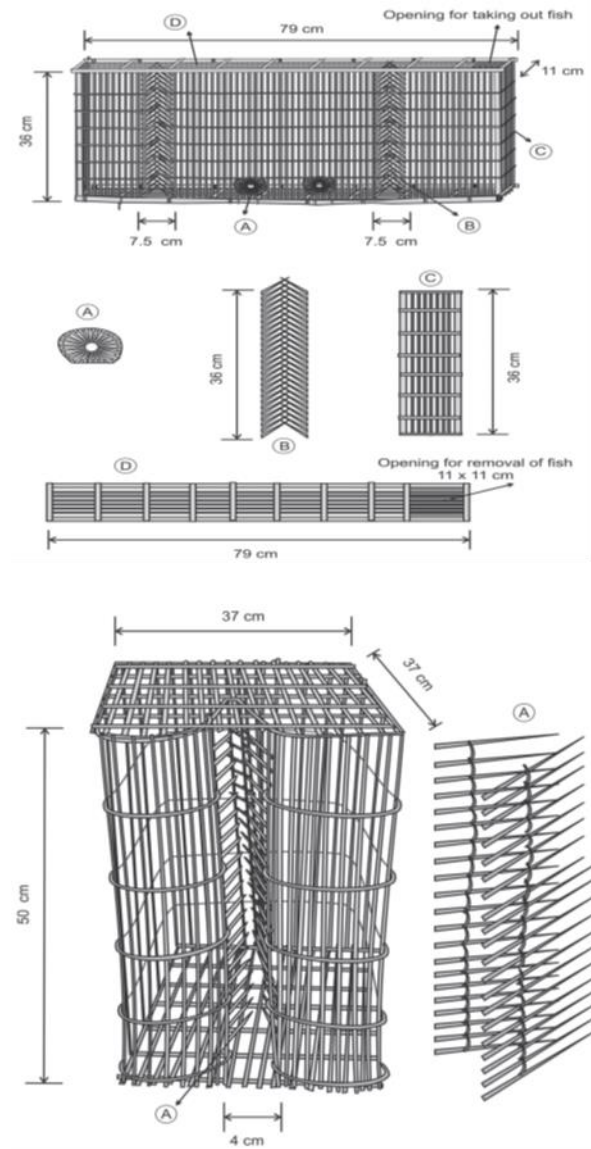

Figure 10a-d: Box trap

This type of trap is staked to the sea bed and perpendicularly to the shore; it extends several tens of metres (or even more) out to sea, it ends in one (downstream of the coastal current, as a rule) or two (one upstream and the other downstream) curved (semicircular) barriers from which the fish seem unable to escape (Pravin *et al.*, 2011).

A trap, like a pot, may be baited to attract species of interest. Special set nets are used as traps; the commonest are

- i. Pound nets
- ii. Fyke nets,
- iii. Stow nets,
- iv. Aerial traps,

- v. Fish fence trap and
- vi. Fish shelter trap (Eyo and Akpati, 1995; Remesan *et al.*, 2007

- Pound Nets

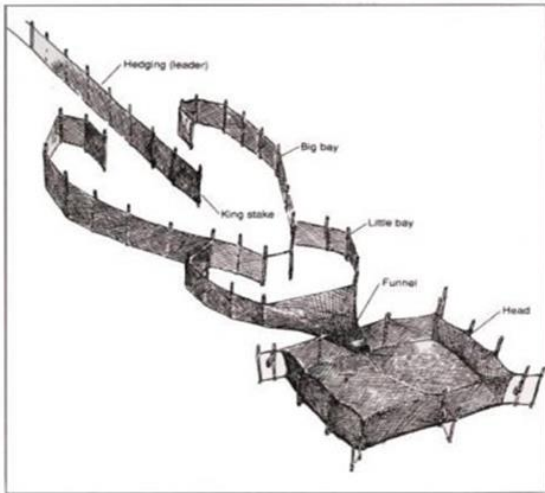
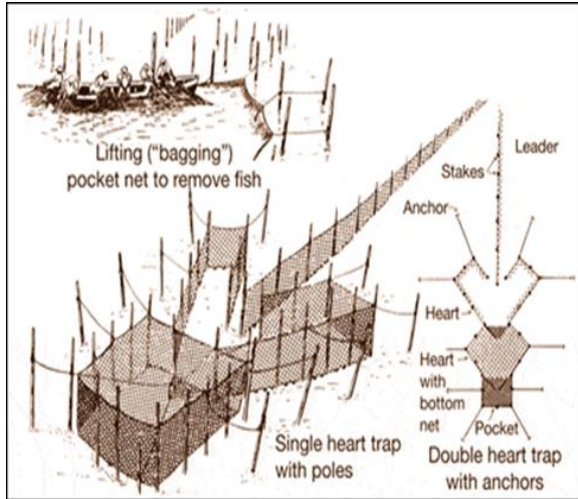

Figure 11a-b: Drawing of a stationary single and double heart pound nets (Eyo and Akpati, 1995; Remesan *et al.*, 2007)

- Fyke Nets

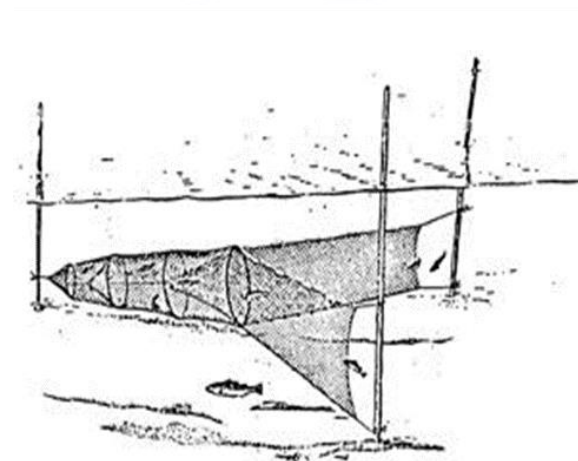
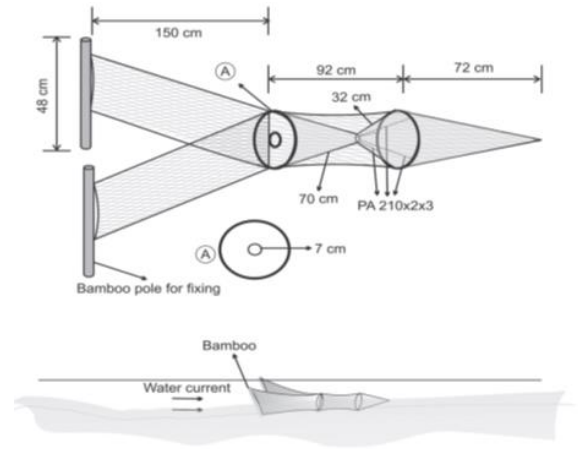
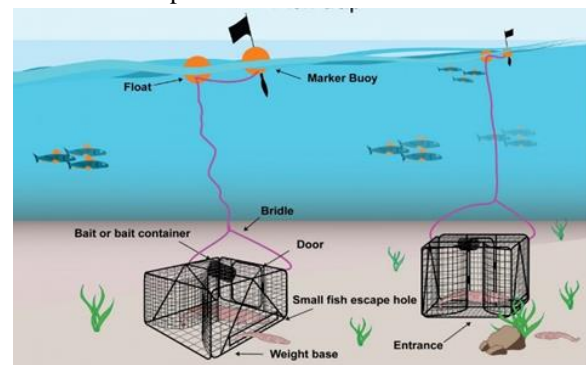

Figure 12a-b: Fyke net (Eyo and Akpati, 1995; Remesan *et al.*, 2007; Pravin *et al.*, 2011)

- Shelter Trap



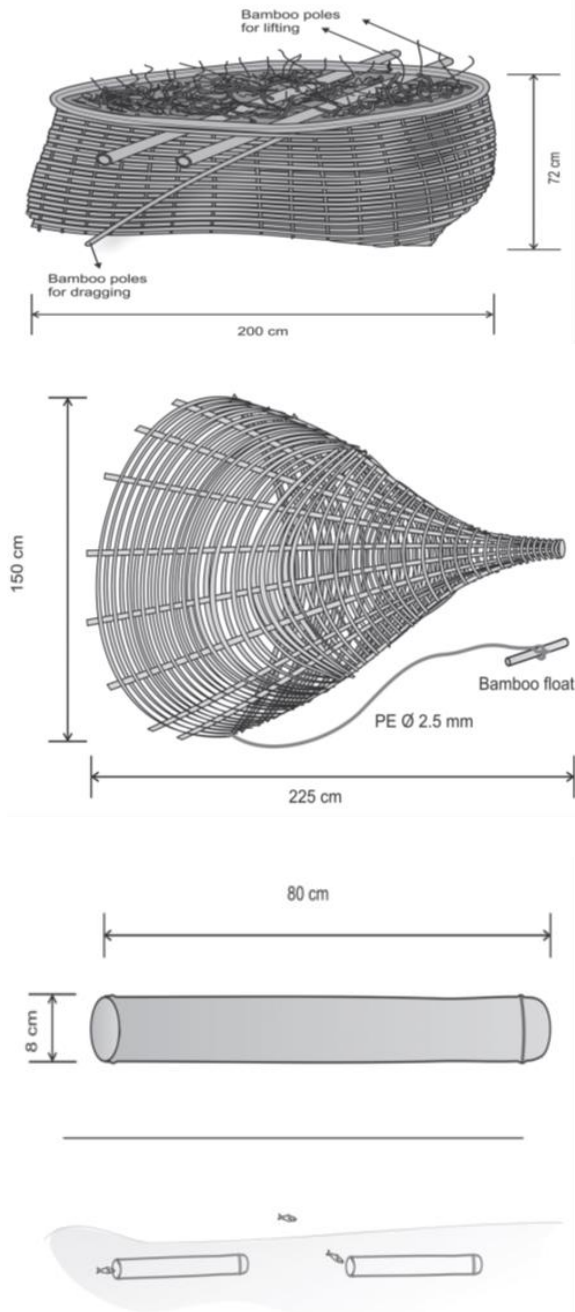

Figure 12a-d: Shelter trap (He, 2006)

- Nets

Types of fishing nets include; Gillnets, Set gillnets, Combined gillnets-trammel nets and Trammel nets (Eyo and Akpati, 1995; Brown, 2016).

- Gillnets

Fish may be caught by gill nets in three ways:

1. Wedged – held by the mesh around the body.

2. Gilled – held by mesh slipping behind the opercula.
3. Tangled – held by teeth, spines, maxillaries, or other protrusions without the body penetrating the mesh (Potter and Pawson, 1991; Brown, 2016).

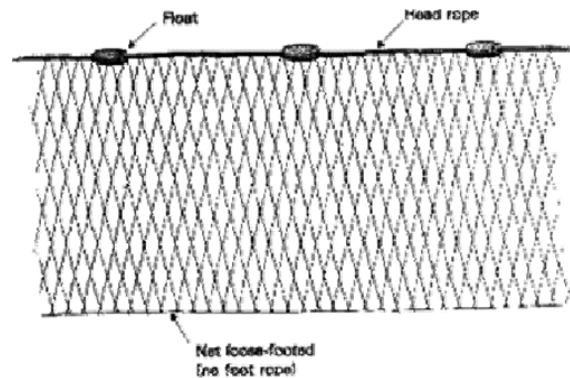
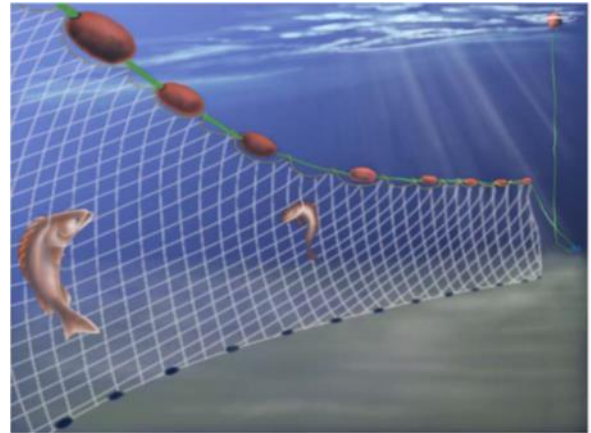

Note: Net is hung very loosely with a hanging ratio of 1:3 or greater.

Figure 13a-b : Gillnet (Brown, 2016)

- Set gillnets

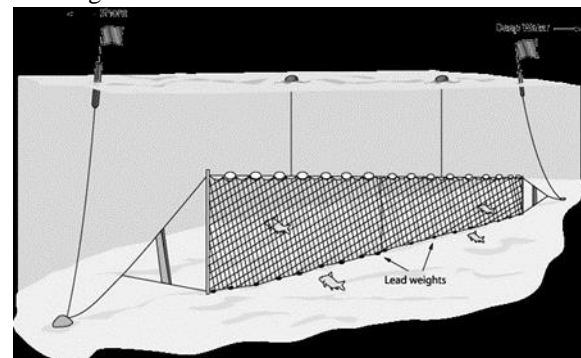

Figure 13c: Set gillnets

- Set gillnets consist of a single netting wall kept vertical by a floatline (upper line/headrope) and a weighted groundline (lower line/footrope).
- Small floats, usually shaped like eggs or cylinders and made of solid plastic, are evenly distributed along the floatline, while lead weights are evenly distributed along groundline.
- The lower line can also be made of lead cored rope, which does not need additional weight.
- The net is set on the bottom, or at a distance above it and held in place with anchors or weights on both ends. (Brown, 2016)
- Combined gillnets-trammel nets

This bottom-set gear has two parts:

- the upper part is a standard gillnet where semi-demersal or pelagic fish can be gilled
- the lower part is a trammel net where bottom fish can entangle.
- The combined nets are maintained more or less vertically in the usual way by floats on the floatline and weights on the groundline.
- They are set on the bottom. After a time depending on the target species, they are hauled on board (Nuhu and Yaro, 2005).

- Trammel nets

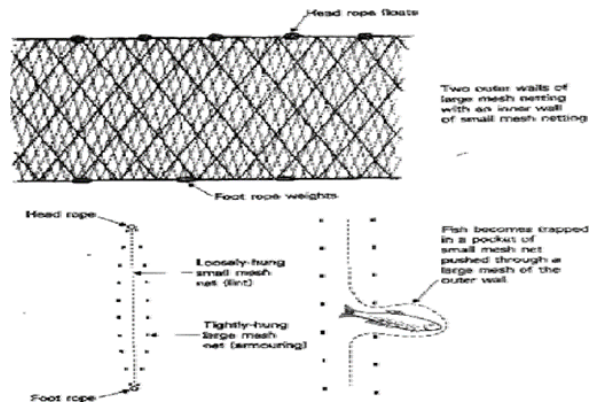

Figure 13d: Trammel net (Nuhu and Yaro, 2005).

- Fish are caught by entanglement, which is facilitated by its special construction of three panels of nets attached on the same rope with a high degree of slackness.
- A trammel net may look like a gillnet. However, while the gillnet has a single panel of meshes, the trammel net has three - one middle panel of small meshes and two side panels of larger meshes.

- When a fish comes in contact with the net, it will press the small mesh net through an adjacent larger mesh so that it is caught by entangling or "pouching" (Nuhu and Yaro, 2005).
- Lift Nets

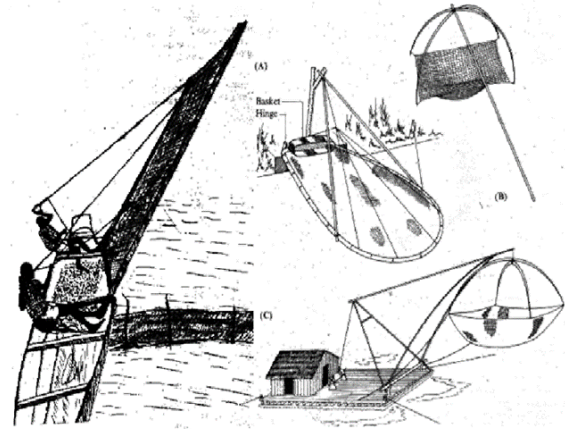

Figure 14: Different types of lift net (atalla). [a] bank mounted lift net – Niger river, [b] hand held lift net – Bangladesh, [c] raft mounted lift net – Mekong and [d] canoe mounted lift net – Anambra river (Eyo and Akpati, 1995)

- Lift nets consist of a horizontal netting panel or a bag shaped like a parallelepiped, pyramid or cone with the opening facing upwards.
- These gears comprise the bag nets ('basnig') and the blanket nets.
- Often, depending on target species the catching process is supported by lights (in cases, a series of powerful ones) or simply some bait.

- Active Fishing Gear Technology

Active gears have to be moved, dragged, or towed in order to capture fish through the water by human, animal or engine. Fish capture by active gears is based on the aimed chase of the target species and combined with different ways of catching it (Meenakumari *et al.*, 2009).

Trolling

- Trolling lines are simple hooked that are trailed from a moving vessel at a controlled depth.
- A trolling line consists of a line with natural or artificial baited hooks and is trailed by a vessel near the surface or at a certain depth.

- Several lines (depending if trolling line is single, double or multiple) are often towed at the same time, by using outriggers to keep the lines away from the wake of the vessel (Brown, 2016).
- The lines are hauled by hand or with small winches. A piece of rubber is often included in each line as a shock absorber.
- Eligible areas include inshore or offshore waters and target species may be pelagic or demersal
- (Murphy and Willis, 1996).

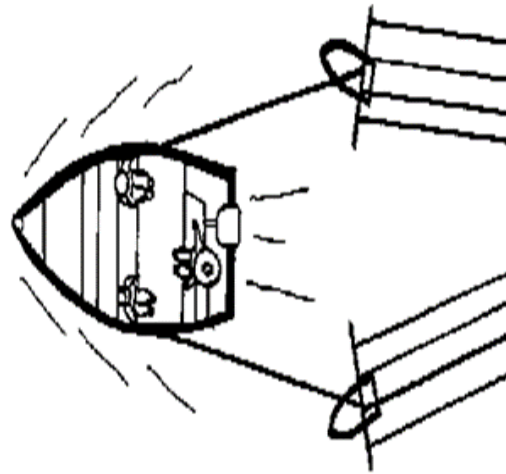
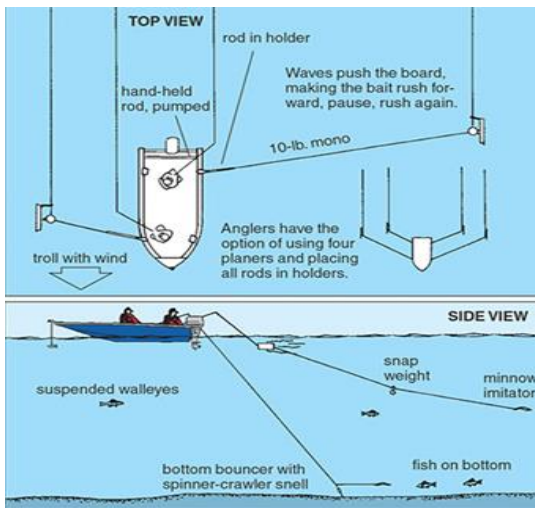

Figure 15a-c: Single, Double and Multiple line trolling (Murphy and Willis, 1996; Brown, 2016)



- Surrounding Nets

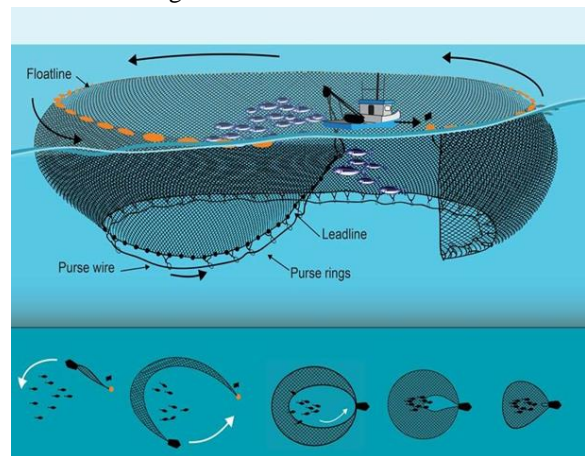

Figure 16: Surrounding nets (Meenakumari *et al.*, 2009)

- Surrounding nets are large netting walls set for surrounding aggregated fish both from the sides and from underneath, thus preventing them from escaping by diving downwards.
- Apart from a few exceptions, these are surface nets. The netting wall is framed by lines: a floatline on top and leadline at the bottom.
- According to the type of surrounding nets gear, specific equipment may be required, the main requirement being some facility for manoeuvring large to very large net (Meenakumari *et al.*, 2009).

- Purse Seines and Ring Nets

Purse seines are characterized by a line at the bottom of the net that is used to close off the escape route. The

purse seine is the foremost type of surrounding net, in which bottom of the net is closed after encircling the fish school, by a purse seine line which prevents fish from escaping downwards by diving. The purse seine set with one or two boats are called ring nets. Light may also be used to attract the target species (Pravin *et al.*, 2011).

• One Boat Operated Purse Seines

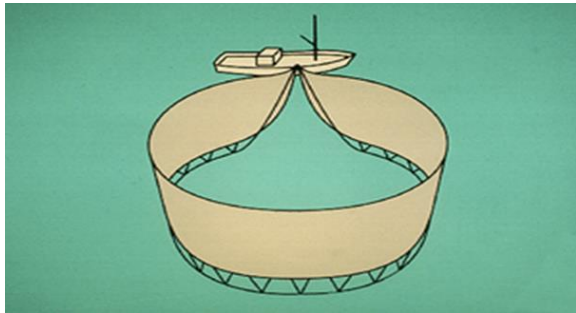

Figure 17: One boat operated purse seines (Boopendranath, 2009)

- The one boat purse seine is set around a detected school of fish.
- After that, the net is closed underneath the school by hauling the purse line running through the rings (pursing).
- Hydroacoustic instruments, like sonars are important tools to locate fish aggregations.

Two Boat Operated Purse Seines

Two boat operated purse seines uses two boat using the following general steps peculiar to purse seines: Approaching fish school, Setting the net, Pursing completed and Brailing (Pravin *et al.*, 2011; Dienye and Olopade, 2017).

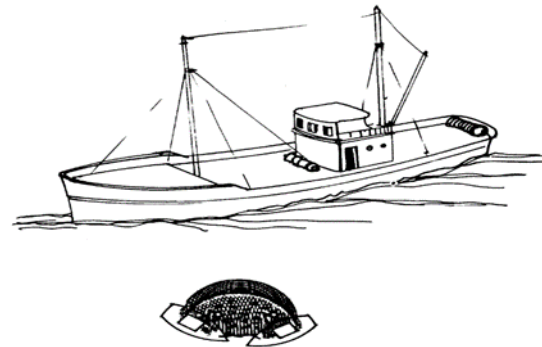
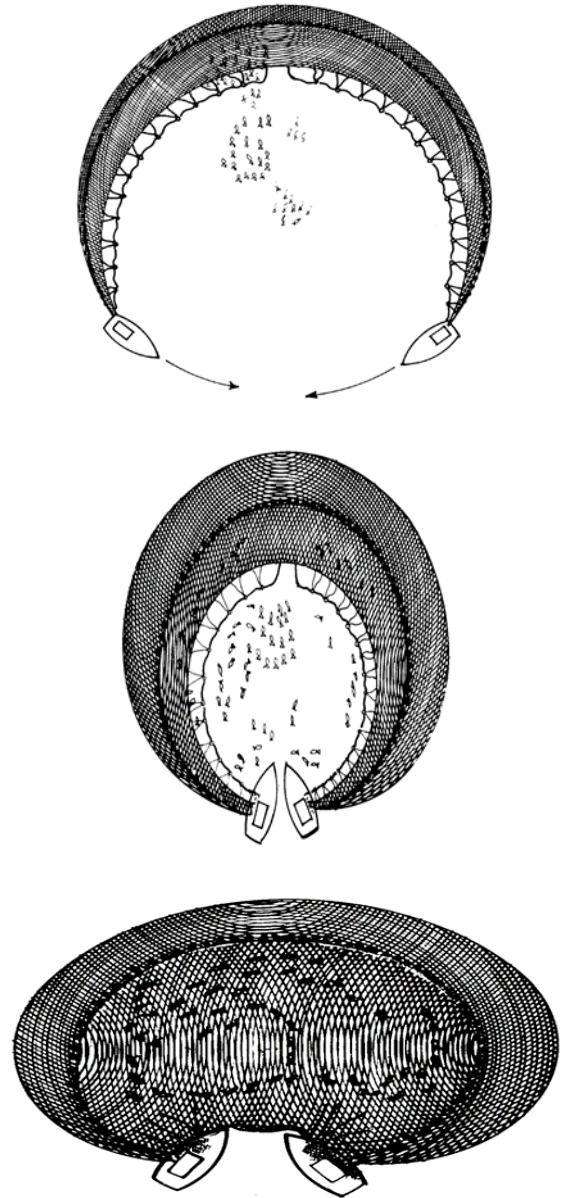
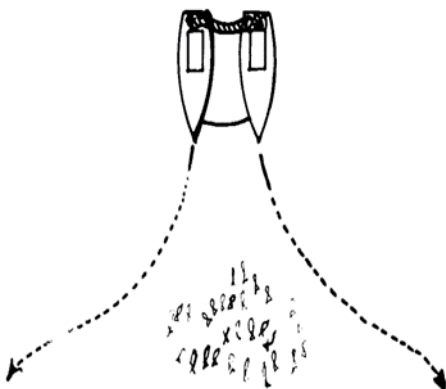

Figure 18: Two boat operated purse seine (Pravin *et al.*, 2011; Dienye and Olopade, 2017)

• Seine Nets

Seine netting is a combination of trawling and seining. When setting the gear, the first warp (rope) is attached to an anchor with a surface buoy (Danish seining) or a buoy only (Scottish seining) and set in a semicircle. Then the seine bag is set before paying out the second warp in another semicircle back to the buoy (attached to the anchor in Danish seining) (Dienye and Olopade, 2017). When the seine and warps have sunk to the bottom, the warps are hauled. As they are tightened, the warps move inwards towards the centre line between the vessel and the seine bag. Fish in the encircled area will then be herded towards the central part of the area. As the warps are further tightened, the seine bag moves forward and catches the fish (Pravin *et al.*, 2011; Dienye and Olopade, 2017).

• Beach Seines

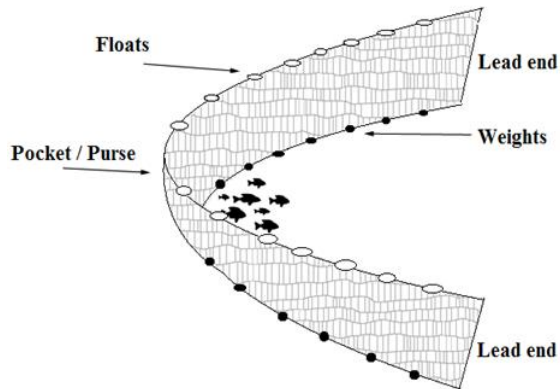

Figure 19: Beach seines (Potter and Pawson, 1991; Bankole *et al.*, 2003).

• Boat Seines

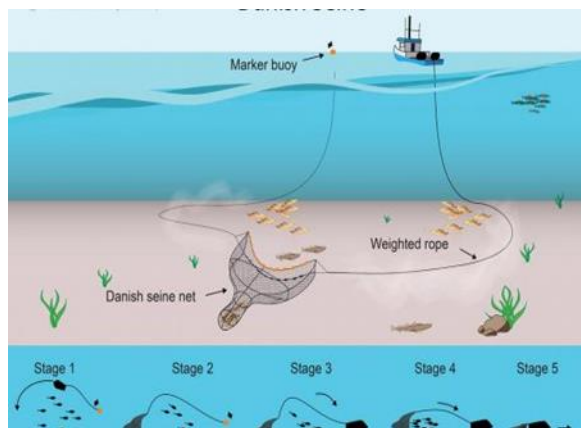
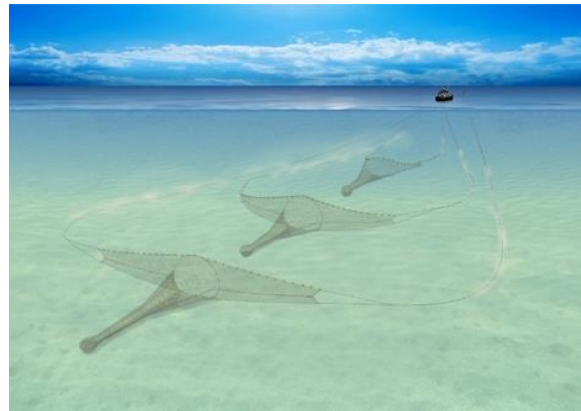

Figure 20: Danish and Scottish boat seines (Dienye and Olopade, 2017)

• Jigging

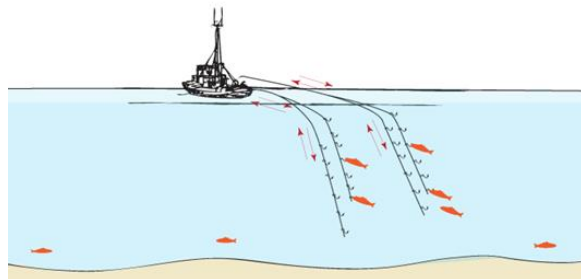

Figure 21: Jigging (Dienye and Olopade, 2017)

- The jiggle technique involves mainly catching fish by impaling them with special hooks.
- In jigging, the line must be jerked to pierce the fish.
- Generally, the sharp hooks are weighted so that when they are pulled up; there will be enough momentum to penetrate the fish skin (BOSTID, 1988).

- In some cases, regular weighted hooks are jigged manually or mechanically to attract fish attention to the bait.
- Clap Nets

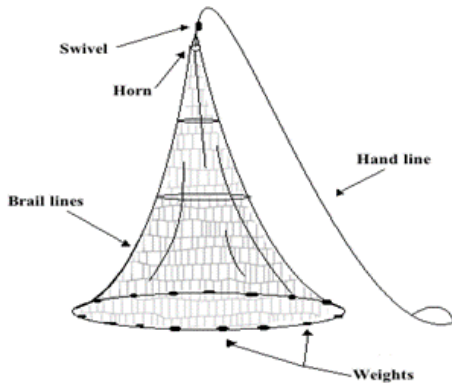
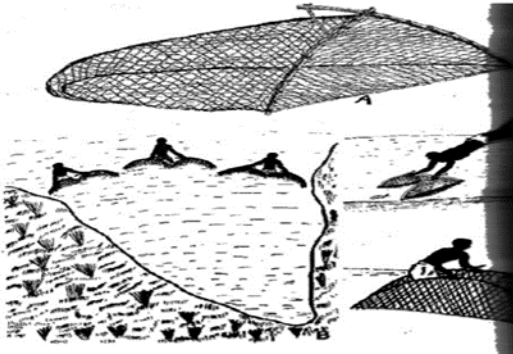

Figure 22: Illustration of clap nets and Casting net (Eyo and Akpati, 1995; Pravin *et al.*, 2011; Dienye and Olopade, 2017)

- Drift Gill Nets

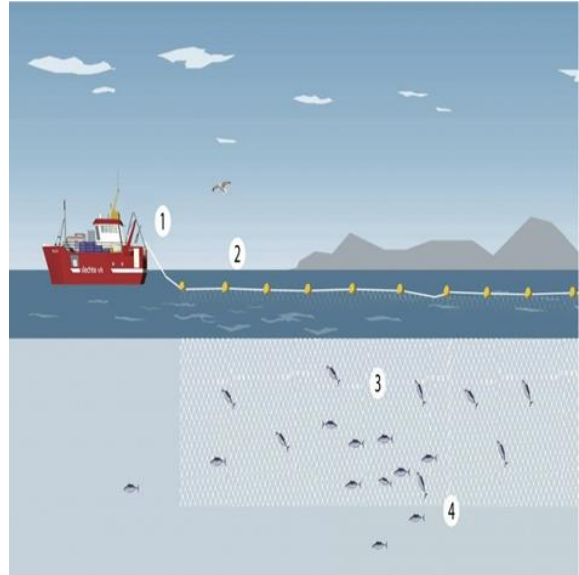

Figure 23: Drift gill nets (Pravin *et al.*, 2011; Dienye and Olopade, 2017)

Drift nets are mobile gill nets which are normally left to drift freely with the current. By adjusting the number of floats and sinkers the net can be made to sink to a desired depth. In operation a large surface float (Calabash) is attached to one end of the net and the other end is fastened to a canoe which drifts along slowly for a long distance with the net before the net is hauled with the catch into the canoe (Fig. 29). Drift nets are effective in rivers devoid of obstacles and are most often used when the floods are receding and during the dry season when the water level is low and the water current not fast. Near Lokoja they are commonly used June and July to catch *Hyperopisus bebe* and in New Bussa area during the month of August. Mechanism of operation:

1. Tow rope;
2. Floats;
3. The gauge of netting is tailored to a specific size of fish;
4. Fish swim into the net and become entangled

Classification of trawls

1. Based on mouth opening device
 - a) Beam trawl
 - b) Bull trawl
 - c) Otter trawl
2. Based on the depth of operation
 - a) Bottom trawl
 - b) Mid water trawl/Pelagic trawl
3. Based on the construction pattern
 - a) Two seam trawl
 - b) Four seam trawl
 - c) Six seam trawl

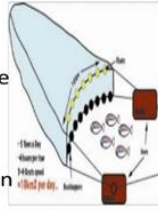

Structure & operation

- Made up from two shaped panels (top & bottom) of netting laced together at each side to form an elongated, funnel shaped bag.
- This funnel tapers down to the cod -end .
- Cod- end--where the fish are collected until the net is hauled.
- The rope at upper edge : headline : has floats
- Side rope : wing lines/gables : weighted ground gear
- Wings connected by bridles/sweeps (length of single wire)
- Doors : steel / wood : attached to boat by warps.

fishing gears

47

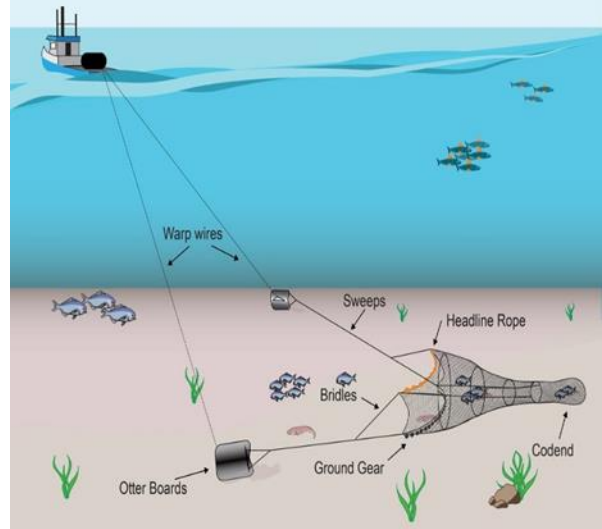
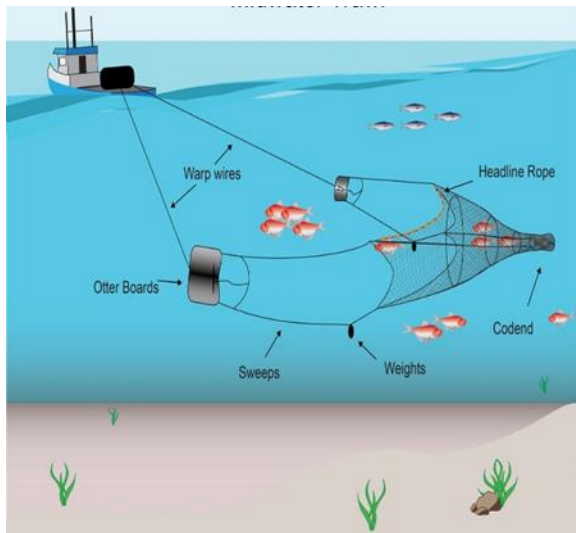
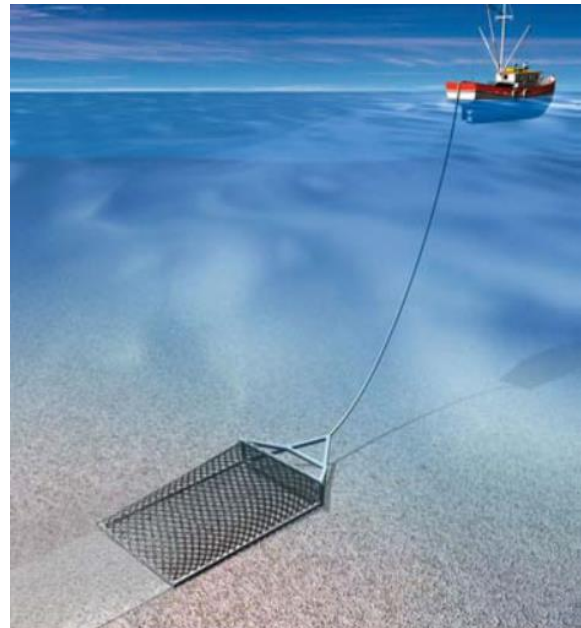
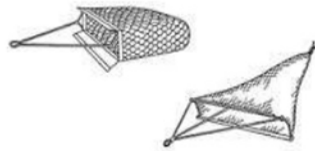

Figure 24: The beam trawl and otter trawl (Pravin *et al.*, 2011; Dienne and Olopade, 2017)

- Dredge



Dredges



- Active gears.
- Used to capture the benthic and sessile organisms
- Usually in the form of metallic frame or cage to which a strong netting is attached.
- Cage has a “mouth” presented to the sea bed during fishing.
- It lower jaw usually metal bar teeth like structure which are 9 to 15cm long.

Figure 24: Illustration of Dredge

- Spears and Harpoons

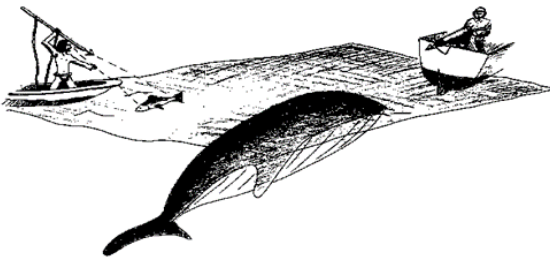

Figure 25: Catching principle and construction of spears and harpoons (Sreekrishna and Shenoy, 2001)

- Is designed for easy penetration of the target organism, but the spear head is equipped with barbs or flukes that hold the prey when it is hit.
- Is connected to the fisher and boat by a line, so that it can be retrieved, with or without catch.
- Often operated from a vessel, but can also be used from land.
- Common target species with this fishing method are flatfish, swordfish, tunas and whales.

- Miscellaneous Fish Viewing

Other fishing technologies used in fishing includes: Direct sensing, Remote sensing, Fish pumping, Fish Finders, Depth Finders, Fishing Aggregate Devices, Fish Lights and Electrical fishing.

- Unorthodox and Obnoxious Fishing Practices
Unorthodox and Obnoxious Fishing Practices includes: Stupefying Example: Explosives

(dynamite), Rotenone (a poison derived from plants) etc, Fishing Poison Example: Gamalin 20, Aldrex 40, Didimacs 25, Atranex, etc. (Udolisa *et al.*,1994; Welcomme, 2001).

XV. RECOMMENDATION

A basic understanding of the properties, function and operation of the major fishing gears technologies and methods is therefore fundamental hence recommended for decision making in fisheries management, particularly when it comes to technical measures in fisheries regulations and fishing gears design to ensure eco-friendly and economic technologies.

CONCLUSION

From experience with fishing gear and literatures on the subject, there has been a continuum in development of fishing gears, with evolution resulting from modernization factors. The adaptation of new technologies could help small scale fisheries increase their catch, but the introduction of any new fishing technology always demands good rational management and regulation. Vessels must also march with new fishing methods and gear. As gears become more complex, it may require updating of vessels in size, power and design making fishing gear technology a progressive continuum.

REFERENCES

- [1] Badapanda, K. C. (2013). Fishing Craft and Gear Technology: Basics of Fisheries Science, Volume 3. Narendra Publishing House, New Delhi.
- [2] Bankole, N. O., Raji, I. A., Adikwu, O. A. and Okwundu, E. C. (2003). Fishing gear survey of Lake Alau, In: Eyo, A. A. and Ajao, E. A. (Eds), *Proceedings of the 16th Annual Conference of the Fisheries Society of Nigeria (FISON)*. Maiduguri, 4th-9th November, 2001: 99-102.
- [3] Boopendranath, M. R. (2009). An overview of fishing gears and their design and construction, in; *Handbook of Fishing Technology* (Meenakumari, B., Boopendranath, M. R., Pravin, P., Thomas, S. N. and Edwin, L., Eds). Central Institute of Fisheries Technology, *Cochin*: 31-66.

- [4] BOSTID (1988). Fishing methods and gear. Pages 49 – 84. In: Fisheries Technologies for Developing Countries. Board on Science and Technology for International Development (BOSTID), National Academy of Science, Washington DC.
- [5] Brandt, A and Lokkeborg, S. (1996). Fish catching Methods of the World. *Fishing News Books, Farnham*: 234
- [6] Cook, R., Sinclair, M. and Valdimarsson, G. (2002). The magnitude and impact of by-catch mortality by fishing gear. *FAO and CABI International Publishing*, 219-234
- [7] Davies, O. A. and Kwen, K. (2012). Fish assemblages of selected traditional fishing traps (Malian and Ikara) in the Upper Nun River, Niger Delta, Nigeria, *FS Journal of Research Basic and Applied Science*, **1**(2):8-11.
- [8] Dienye, H. E. and Olopade, A. O. (2017). A Review of Fishing Methods and Gears in Niger Delta Nigeria. *Journal of Natural Sciences Research*, **7**(6): 98-102
- [9] Eyo, J. E. and Akpati, C. I. (1995). Fishing gears and Methods. Pages 143 – 159. In: Ezenwaji, H.M.G., Inyang, N.M. and Orji, E. C. (Eds.). *Proceedings of the UNDP-Sponsored Training Workshop on Artisanal Fisheries Development*. Held at University of Nigeria, Nsukka, October 29 – November 12, 1995.
- [10] Hameed, M.S. and Boopendranah, M.R. (2000). *Modern Fishing Gear Technology*, Daya Publishing House, Delhi, 186.
- [11] He, P. (2006). Gillnets: gear design, fishing performance and conservation challenges. *Marine Technology Society Journal*, **40**: 12-19.
- [12] Meenakumari, B., Boopendranath, M. R., Pravin, P., Thomas, S. N. and Edwin, L. (2009). *Handbook of fishing technology*. (Ed.). Central Institute of Fisheries Technology, Cochin.
- [13] Mohanrajan, M. (1993). Fish trapping devices and methods of southern India, *Fishing Technology* **36**: 85-92.
- [14] Moore, G. and Jennings, S. (2000). *Commercial fishing (the wider ecological impacts)*. Blackwell Science Ltd., Oxford: 72
- [15] Moses, B.S. (1992). *Introduction to Tropical Fisheries Second Edition*. Ibadan. University Press, :133
- [16] Murphy, B. and Willis, D. (1996). *Fisheries Techniques: Second edition*. Bethesda, MD: American Fisheries Society, 23-45.
- [17] Nédélec, C. and Prado, J. (1990). Definition and classification of fishing gear categories. *F.A.O Fisheries Technical Paper 222. Revision 1*. FAO, Rome. 92.
- [18] Nuhu, M. B. and Yaro. I. (2005). Selection of efficient hanging ratio of gill net on fish catch in Lake Kainji as a means of alleviating poverty among artisanal fisherman in Nigeria. In: P.A.Araoye(eds). *Proceedings of the 19th Annual Conference to Tropical Fisheries Society of Nigeria(FISON)*:64-72
- [19] Pravin, P., Meenakumari, B., Baiju, M., Barman, J., Baruah, D. and Kakati, B. (2011). Fish trapping devices and methods in Assam - A review, *Indian Journal of Fisheries*, **58**(2): 127-135.
- [20] Remesan, M. P., Pravin, P. and Meenakumari, B. (2007). Collapsible fish traps developed for inland fishing. *ICAR News*, **13**(1): 117-118.
- [21] Tagago, T. A. and Ahmed, Y. B. (2011). Fishing gear survey of Tatabu floodplain, In: Koko, R.J. and Orire, A.M. (Eds), *Proceedings of the 26th Annual Conference of the Fisheries Society of Nigeria (FISON)*. 28th November-2nd December, Minna, Niger State, Nigeria: 109-116.
- [22] Udolisa, R. E. K, Solarin, B. B. Lebo, P. and Ambrose, E. E. (1994). A catalogue of small-scale fishing gear in Nigeria. *RAFR Publication RAFR.014/FI/94/02*: 142
- [23] Welcomme, R. L. (2001) *Inland Fisheries: Ecology and Management*. F.A.O *Blackwell science*: 358-636.
- [24] Potter, E. C. E. and Pawson, M. G. (1991). Gill Netting. *MAFF Fisheries Leaflet*, 69.
- [25] Brown, E. (2016). Fishing Gear 101: Gillnets – The Entanglers - The Safina Center. Retrieved August 20, 2016, from <http://safinacenter.org/2015/03/fishing-gear-101-gillnets-entanglers/>