

Simulation Analysis of Information Transmitting Mechanism Based on Amplitude Modulation Technique

C.T. IKWUAZOM¹, U. M. OBI², J.E. JIBIRI³, I.A. AMAEFULE⁴, D. O. NJOKU⁵, C.D. ANYIAM⁶

¹ Department of Information Media Technology, Federal University of Technology, Minna, Niger State-Nigeria

^{2, 5, 6} Department of Computer Science, Federal University of Technology, Owerri, Imo State-Nigeria

³ Department of Information Technology, Federal University of Technology, Owerri, Imo State-Nigeria

⁴ Department of Computer Science, Imo State University, Owerri, Imo State-Nigeria

Abstract- *This paper has presented simulation analysis of information transmitting mechanism based on amplitude modulation (AM) technique. In AM technique, the amplitude of carrier signal is varied in proportion to the continuous time amplitude of the message signal. The study has modelled an AM modulating and demodulating system in MATLAB/Simulink environment. Three different scenarios were considered in terms of varying modulation index. The values of modulation indices selected are 1, 0.5 and 1.5 representing perfect, under and over modulations respectively. The results indicated that at modulation indices of 0.5 and 1, the modulating signals produced no distortion. However, selecting a modulation index of 1.5 produced distortion in the transmitted information and as such choosing a modulation index of above one will not be suitable in the transmission of information in AM system.*

Indexed Terms- *Amplitude modulation, Information, Modulation index, Transmission*

I. INTRODUCTION

There has been rapid development witnessed in radio communication technologies in the last two decades. One of the techniques that have enabled the growth of communication system is the modulation scheme employed. The various generation of mobile wireless communication differ from one with respect to access to radio network, speed (or rate) of data transmission, bandwidth and switching techniques [1]. It is not possible to achieve radio link communication as constituted today without modulation starting from the method of data transmission from the first generation

(1G) network, which is basically analogue system to the most recent fifth generation (5G) network that is digital data transmission system.

Modulation is achieved by varying one or more properties of carrier signal, which is a periodic waveform, with a modulating symbol that usually contains the information to be transmitted. Performing modulation process involves the use of certain electronic device known as modulator. The inverse of modulation called demodulation is carried out at the demodulator (or detector). It should be noted that both processes can be carried out separately at different ends or locations –modulation takes place at the transmit end (transmitter) while demodulation is performed at the receive end (receiver). However, the two processes or operations, modulation/demodulation, can be carried out at the same locations within a single device called modem (from modulator-demodulator).

For transmitting data stream over communication channel, a modulation system is required. There various methods of modulation, which are: frequency modulation (FM) which involves varying the frequency of the carrier wave according to the frequency of the modulating signal, amplitude modulation (AM) that entails varying the amplitude of the carrier wave according to the modulating signal, and phase modulation (PM) schemes in which data is encoded by varying the phase of the signal. The AM, FM, and PM modulations are analogue modulation technique. There is also digital modulation such as quadrature amplitude modulation (QAM), frequency-shift keying (FSK) and phase-shift keying (PSK). However, there are criteria for selecting the

modulation technique such as spectral efficiency, power efficiency, and complexity of system [2].

Amplitude modulation (AM) is of three types: perfect modulation, under modulation, and over modulation. The type of AM modulation is decided by the modulation index μ [3]. The modulation index μ refers to ratio of modulating signal amplitude to carrier signal amplitude. Perfect modulation occurs when μ is equal to one and when μ is less than one; the AM is under modulated. Then for μ greater than one; the AM is over modulated [3].

This paper will focus on information transmitting process-based AM scheme. It is aimed at using computer simulation tool –MATLAB/Simulink software to conduct analysis of AM technique. Furthermore, to examine real-time transmission of analogue information such as music, voice, and video for Double-Side-Band (DSB)-AM modulated signal via a transceiver modelled in Simulink simulation environment.

II. MATHEMATICAL MODEL OF AMPLITUDE MODULATION AND DEMODULATION

This section provides the basic concept of signal modulation and is represented by the model shown in Fig. 1. The reason for modulation is to compensate for weakness or limitation inherent in audio signal, which has a frequency range 0-20 KHz and a minimum wavelength of 15 Km [4]. Transmitting this range of frequencies directly as electromagnetic wave will not be feasible because any attempt to do so will require that too expensive and prohibitive sizes of the transmit and receive antennas be installed at both ends of the communication system.

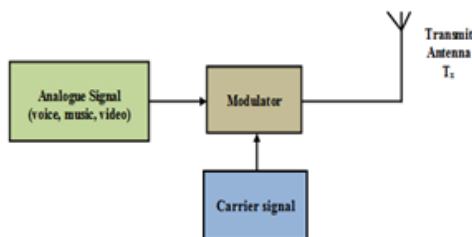

Fig. 1 Simplified block diagram of modulation process

It can be seen from Fig. 1 that the analogue signal to be transmitted is combined with a carrier signal at the modulator and the ensuing signal is called modulated signal whose signal strength has been amplified and is transmitted in form of electromagnetic radiation. For a typical electromagnetic wave, the speed or velocity c of propagation in space is given by:

$$c = f \times \lambda \tag{1}$$

where $c = 3 \times 10^8 \text{ ms}^{-1}$, f is the frequency of transmission in hertz (Hz), and λ is the wavelength expressed in metre (m).

Let the frequency of the carrier signal in radians per second, ω_c be given by:

$$\omega_c = 2\pi f_c \tag{2}$$

where f_c is the frequency of the carrier signal.

For amplitude modulation, f_c is much larger than the audio frequency band, W (that is $f_c \gg W$) [4, 5]. Then the amplitude modulated $s(t)$ can be expressed in terms of the audio message signal $m(t)$ that is band limited to W in Hz and the amplitude of the message A_c given by [4, 6]:

$$s(t) = A_c [1 + \mu m(t)] \cos(2\pi f_c t) \tag{3}$$

$$s(t) = A_c \cos(2\pi f_c t) + A_c \mu m(t) \cos(2\pi f_c t) \tag{4}$$

where μ is a constant (modulation index) defined in $-1 < \mu < 1$ [5].

For AM demodulation, the Square-Law technique is considered as follows [5]:

$$s^2(t) = \{(1 + \mu m(t)) \cos(2\pi f_c t)\}^2 \tag{5}$$

$$s^2(t) = \frac{1}{2} (1 + \mu m(t))^2 + \frac{1}{2} (1 + \mu m(t))^2 \cos(4\pi f_c t) \tag{6}$$

The signal is fed through a low pass filter to remove the high frequency component. Thus after filtering, Eq. (6) is then given by:

$$s^2(t) = \frac{1}{2} (1 + \mu m(t))^2 = \frac{1}{2} (1 + \mu m(t)) \times \frac{1}{2} (1 + \mu m(t)) \tag{7}$$

Therefore, the demodulated signal is given by:

$$M(t) = \frac{1}{4} (1 + \mu m(t)) \tag{8}$$

III. MATH

In this section, the AM modulation and demodulation processes are represented by using embedded blocks of the MATLAB/Simulink to develop models representing the earlier established by mathematical equations.

A. Simulink Model of Amplitude Modulation

The AM modulation model consists of the audio signal (message) that is multiplied by modulation factor (or index) and a unit constant is added to it. The resulting effect after the summation is multiplied with a carrier signal and the result is a modulated signal as shown in Fig. 2.

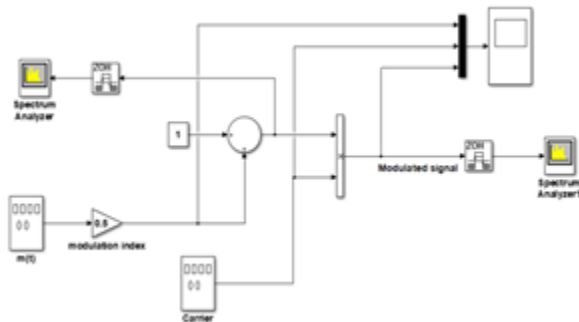

Fig. 2 Model of AM modulation

B. Simulink Model of AM Demodulation

The AM demodulation model is that of Square-Law represented in Simulink. The modulated signal is fed into a math function block that squares the received signal and then after it scaled by a factor of 2. The analog filter removes high frequency signal in the received signal while allowing the low frequency ones to pass. After the signed square root operation and the addition of a unit constant as shown in Fig. 3, the resulting signal is a demodulated signal that is approximately of the same form as the original message.

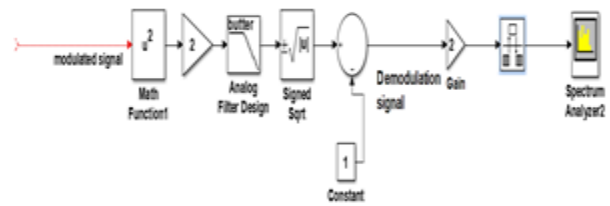

Fig. 3 Model of AM demodulation

C. Simulink model of System

Figure 4 shows the Simulink model of DSB-AM.

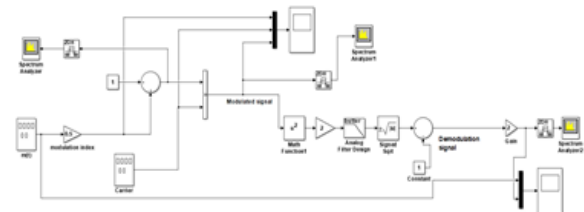

Fig. 4 Simulink model of AM modulation and demodulation

IV. SIMULATION RESULTS

With the model developed and simulations conducted in MATLAB/Simulink environment, the results obtained are presented by assuming different scenarios of modulation index (that is $\mu = 1, 0.5, 1.5$) representing perfect, under, and over modulations. It should be noted that the message frequency is set as 1 kHz, while the carrier frequency is adjusted as 20 kHz.

A. Perfect Modulation

Figures 5, 6 and 7 show the simulation results obtained from the spectrum analyzers and the scopes for the message (or audio) signal, carrier, modulated signal, and demodulated when $\mu = 1$.

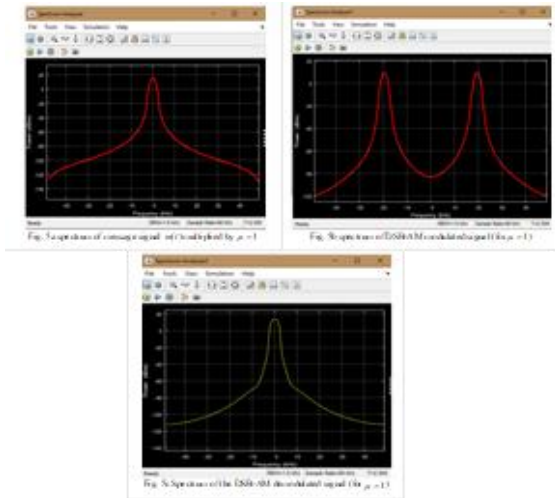

Fig. 5 Simulation plots from spectrum analyzer (for $\mu = 1$)

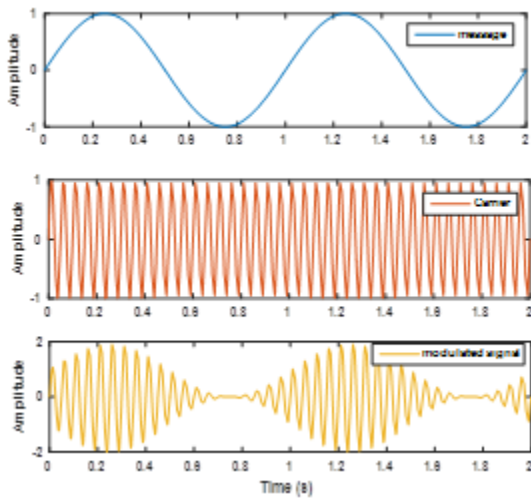

Fig. 6 Simulation plots of message, carrier, and modulated signal (for $\mu = 1$)

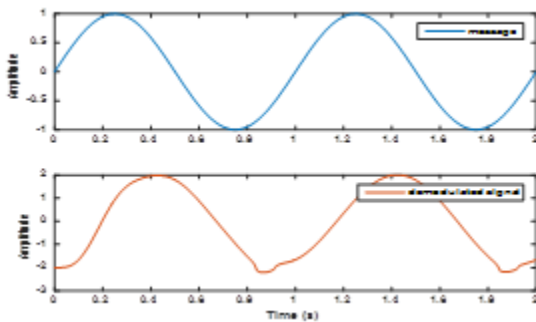

Fig. 7 Simulation plots of message and demodulated signal (for $\mu = 1$)

B. Under Modulation

In this case, $\mu = 0.5$ and the resulting simulation plots from the spectrum analyzers and scopes are shown in Fig. 8, 9 and 10 for message, carrier, modulated signal, and demodulated signal respectively.

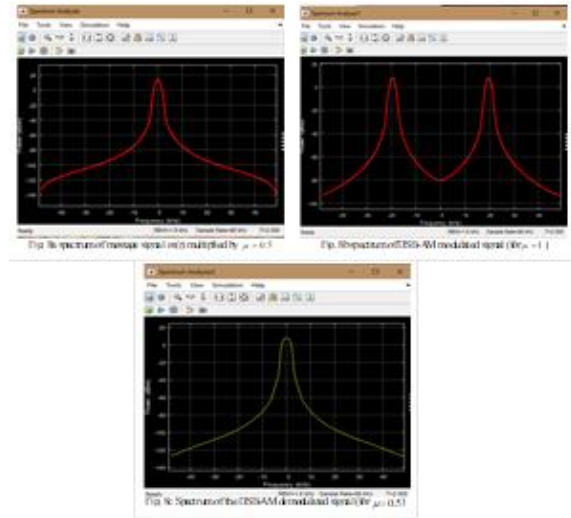

Fig. 8 Simulation plots from spectrum analyzer (for $\mu = 0.5$)

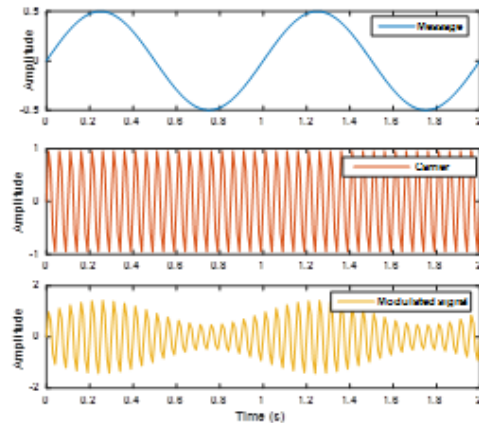

Fig. 9 Simulation plots of message, carrier, and modulated signal (for $\mu = 0.5$)

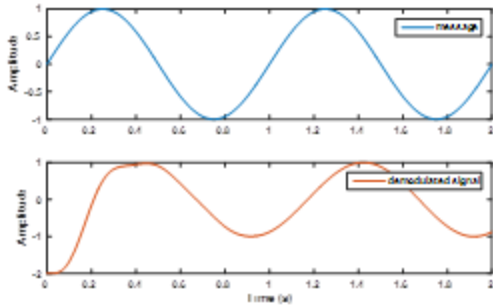

Fig. 10 Simulation plots of message and demodulated signal (for $\mu = 0.5$)

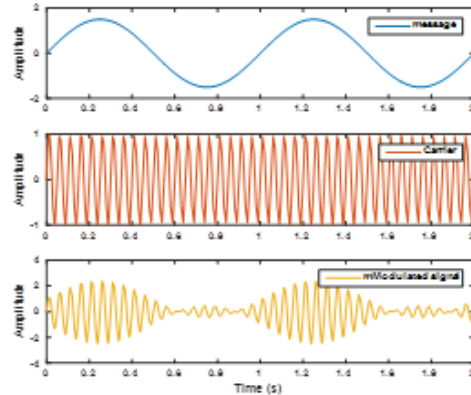

Fig. 12 Simulation plots of message, carrier, and modulated signal (for $\mu = 1.5$)

C. Over Modulation

The simulation results from the spectrum analyzers and the scopes when the message (information) is scaled by modulation factor $\mu = 1.5$ are presented in this scenario in Fig. 11, 12 and 13.

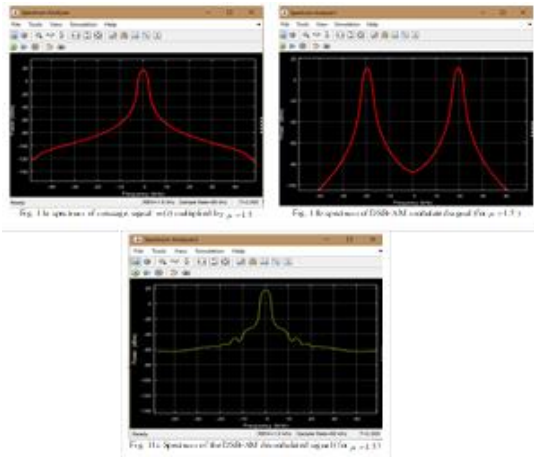

Fig. 11 Simulation plots from spectrum analyzer (for $\mu = 1.5$)

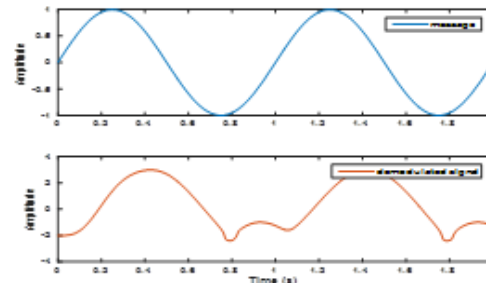

Fig. 13 Simulation plots of message and demodulated signal (for $\mu = 1.5$)

Looking at the simulation plots from the spectrum analyzer, the spectrum of the modulated signal revealed Double Side Band amplitude modulation. The amplitude modulated (AM) signal is observed to consist of the original carrier frequency of 20 kHz, with lower frequency and higher frequency components. These frequencies (lower and higher) are symmetrically located around the carrier. The scope results for the message, carrier and modulated signal revealed that with different modulation index, various degrees of modulation are obtained. With the message and carrier taken to be sine waves and the value of the modulation index selected for 0.5 (50%) and 1 (100%), it can be seen no distortion occurred. In fact, the selection of 100% modulation index provided perfect modulated signal as shown in Fig. 6. However, with the modulation index selected as 1.5 that is above 100% (over modulation), distortion can be observed in the modulated signal. Even the demodulated signal for the case of for 1.5 modulation index showed distortion. Thus, over modulation produces severe distortion and interference in the transmitter output

[7]. Hence, for transmitting information in communication system, modulation index of 100% will be desirable for AM technique.

[7] B. L. Theraja, *Basic electronics (Solid state)*, 5th ed., S. CHAND, New Delhi.

CONCLUSION

In this paper, amplitude modulation (AM) has been implemented in MATLAB/Simulink environment. The model for amplitude modulation and demodulation has been developed using the Simulink library tool, which are basically communication blocks in the library. In the simulation study, the modulating signal (message), carrier signal and modulated signal. Three different scenarios were considered in terms of modulation indices of 0.5, 1, and 1.5. Thus, it can be said that amplitude modulation depends on the modulation index. Generally, modulation index of 0 to 100% produces better information transmission without distortion.

REFERENCES

- [1] G. N. Kareem, G. A. Gbotoso, and S. O. Omogoye, MATLAB analysis and Simulink model for amplitude modulation technique, *World Journal of Advanced Engineering Technology and Sciences*, 2(2), 2021, 21-28.
- [2] D. Mitić, A. Lebl. Selection procedure for modulation using simulation in Matlab, MIPRO 2011 - 34th Int. Conv. Inf. Commun. Technol. Electron. Microelectron. - Proc. 2011, 547-552.
- [3] R. R. Suryawanshi, and V. D. Patils, Simulink implementation of amplitude modulation technique using Matlab, *International Research Journal of Engineering and Technology*, 5(8), 2018, 185-189.
- [4] M. Boulmalf, Y. Semmar, A. Lakas, and K. Shuaib, teaching digital and analog modulation to undergraduate information Technology students using Matlab and Simulink, *IEEE EDUCON Education Engineering*, 2010, Madrid, Spain, 685-691.
- [5] Lab 1: Amplitude Modulator and Demodulator, ECE Undergraduate Laboratories, ECE 489 Communications Systems Laboratory.
- [6] H. Taub, D. L. *Principles of Communication Systems (3rd ed.)*. McGraw Hill.