

# Design And Construction of a Microcontroller Based Automatic Plant Watering Device for A Sustainable Environment

OLAYIWOLA, J.O<sup>1</sup>, ADAMU, DAHIRU<sup>2</sup>

<sup>1,2</sup> Department of Computer Engineering, Federal Polytechnic Ilaro, Ogun state, Nigeria

**Abstract-** Many People enjoy living around the plants due their benefits to mankind and the environment. Regular watering of plats is among the major factor that will keep them healthy and alive. Considering when and how much water needed by plants is two significant aspects of watering process. To make the work smart, an automatic plant watering system was developed to manage resources. The device is controlled using ATmega328 microcontroller which is manipulating the moisture content of the soil and gives out the signal to the water pump. The system was programmed to sense moisture level of plants at a given time. If the moisture content is below the specified threshold moisture value stated in the program code, then desired volume of water is supplied until it reaches threshold moisture value. This system can be used in greenhouse operation for small and large gardens.

**Indexed Terms-** Automatic Watering System, Environment, Microcontroller, Moisture sensor, water Pump

## I. INTRODUCTION

Many people love to have plants around them. Having plants around the environments (house, schools, hospitals, etc) are very beneficial in many aspects of human beings lives. Plants help in keeping the environment healthy by producing oxygen and cleaning air naturally (Tashneem, 2018). Environmental sustainability is involved with the state of the environment in which we dwell. It encourages people to live in a way that produces little waste and even regenerates some of the resources we use on a daily basis. The increasing demand for sustainable development and beautification of the environment requires the rapid improvement in the technology used in catering for the plants. In a country like Nigeria, where we have two seasons: raining and dry season.

During the dry season, the plants will suffer insufficiency in water supply which would stunt the growth of plants that have been planted. Many individuals forget to water their plants owing to their hectic daily schedules, and as a result, their plants suffer from a variety of ailments and eventually die. Therefore, it is essential to manage the supply of water to plant efficiently (Divani Patil & Punjabi, 2016).

Healthy plants require regular watering, which results in an increase in the humidity of the greenhouse air. A high relative humidity (above 80%) can increase the incidence of the disease and plant transpiration and should be avoided (Gupta et al., (2016).



Smart irrigation system seems to be helpful especially for those who engaged with day-to-day activities. If designed and constructed properly, automatic irrigation systems can be effective by saving energy and lot of water conservation (Bishnu et al., 2017). Traditional watering methods prove to be time consuming, less sensitive and wastes water. Automatic plant watering systems can be designed in a way that regulates the amount of water supply in a targeted area as it when needed.

This work uses ATmega 328 microcontroller to control the flow of water that goes to the plant. The microcontroller is programmed on Arduino board using the IDE application software. This was archived on the principle of measuring the soil moisture level at a given time. The moisture sensor measures the level of moisture in the soil and sends the corresponding analog signal values to the microcontroller for necessary decision/action.

II. COMPONENTS USED FOR IMPLEMENTATION OF SYSTEM

To build an automatic plant watering system, following components are needed.

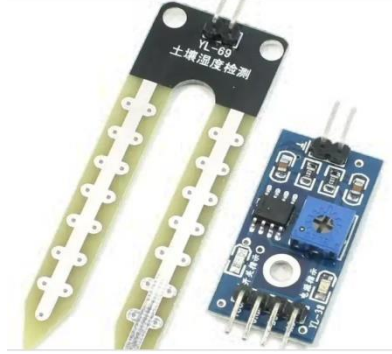
Table 1: COMPONENTS SPECIFICATION

S/N	COMPONENTS	COMPONENTS SPECIFICATION	DIAGRAM
1	Arduino Uno (ATmega328)	AVR RISC-based microcontroller with 14 digital I/O pins, 6-channels 10-bit A/D converter, 2KB SRAM, 1024B EEPROM, and 32KB ISP flash memory. 7V to 12V operating voltage	
2	Moisture Sensor	Output value Dry soil 0-300 Humid soil 300-700 Water 700-950 Output voltage signal 0-4.2v Operating voltage 3.3v to 5v	
3	12V DC Mini Brushless water pump	Input voltage: DC 5-12V Current Max:0.5A Continuous working life (24hrs nonstop) Maximum flow: 350L/H	
4	UB12100-S Universal Battery	Lead Acid Battery 12V 10Ah	

III. HARDWARE CONFIGURATION

- BLOCK DIAGRAM

In this work, three major functional components were used; soil moisture sensor, water pump and Arduino Uno board. The microcontroller was programmed using Arduino IDE application software. Soil

moisture sensor was embedded into the plant which measures the level of moisture in the soil and send to the microcontroller. Block diagram for the automatic watering system is shown in Figure 1 below.

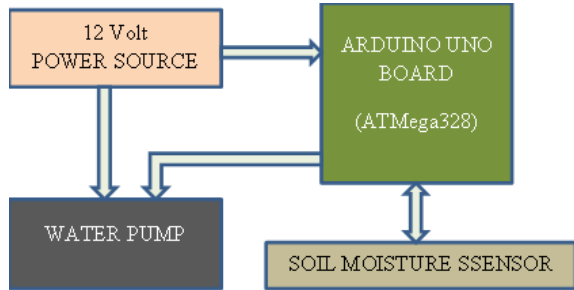

Figure1. Block Diagram for Automatic Watering System

• WORKING PRINCIPLE

The principle behind this system is in embedding the soil moisture sensor into the plant to the ATmega328 microcontroller; establish communication between the controller and other electronic components. The microcontroller sends signal to the water pump upon reception of the moisture level below the threshold value setup in the program which triggers the water pump to turn ON thereby supplies water to the plants until the desired moisture level is reached then turn OFF. Water pump operate at a 12-voltage level whereas microcontroller sends out signals at 5 voltage level. However, Darlington amplifier was used to amplify the 5-voltage signal received from the microcontroller to 12 voltages for normal operation of water pump. The overall system operated at the recommended voltage of 12 volts. Main circuit diagram for the automatic watering system is shown in Figure 2 below.

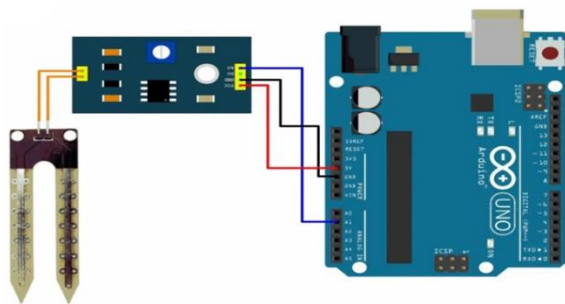

Figure2: Circuit diagram for the automatic watering system

• Flowchart

The software programming of an automatic watering system was guided by a flowchart shown in figure 3 below.

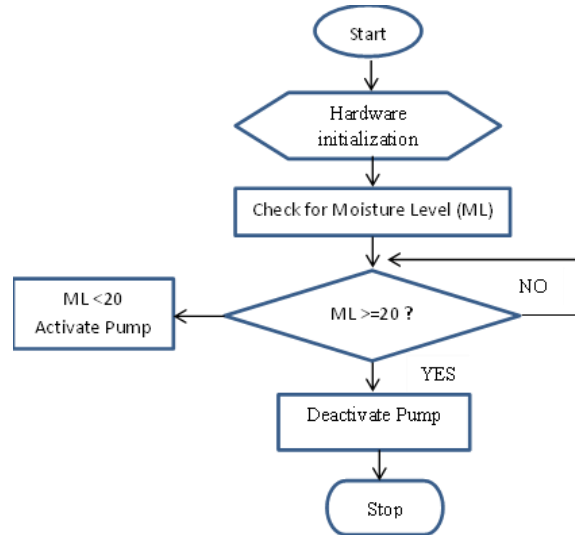

Figure3: System's flowchart

• Software Programming

Apart from the design and hardware setup, a set of instructions (or a program) to control the operation of the system with the aid of a microcontroller on the Arduino board was developed. ATmega 328 microcontroller was programmed using the Arduino IDE application software. The software was created in the Arduino IDE using the built-in C language. The instructions (codes) are written, compiled, and then uploaded to the ATmega328 microcontroller using the Arduino IDE. The program design was guided by a flowchart shown in figure 4.

```

File Edit Sketch Tools Help
soil_moisture
1
2 int relayPin = 8;
3 int sensor_pin = A0; // Soil Sensor input at Analog PIN A0
4 int output_value ;
5 void setup()
6 {
7   Serial.begin(9600);
8   pinMode(relayPin, OUTPUT);
9   pinMode(sensor_pin, INPUT);
10  Serial.println("Reading From the Sensor ...");
11  delay(2000);
12 }
13
14 void loop()
15 {
16  output_value= analogRead(sensor_pin);
17  output_value = map(output_value,550,10,0,100);
18  Serial.print("Moisture : ");
19  Serial.print(output_value);
20  Serial.println("%");
21  if(output_value<20) {
22    digitalWrite(relayPin, LOW);
23  }
24  else
25  {
26    digitalWrite(relayPin, HIGH);
27  }
28  delay(1000);
29 }
30

```

Figure4: Program Code

## CONCLUSION

Automatic Plant Watering System has been implemented and tested to function automatically. Features of all the hardware components used are been integrated during the development process. Normal working condition of every hardware unit wired and software IDE contributes to the best working state of the system. The moisture sensors sense, measure the moisture level of the plants and send to the microcontroller. If the moisture level is found to be below the desired level, microcontroller will triggers the Water Pump to turn ON and supply the water to the plants. When the desired moisture level is reached, the system sends another signal to Water Pump to turn OFF. Thus, the automatic operational capability of this system requires the minimum quantity of water for the irrigation system.

## RESULT

In this work, automatic plant watering system have been constructed and implemented. Basically, the system designed can serves as the introduction to the embedded technology in smart irrigation system. The existing moisture level of the plant was measured and desired volume of water needed by that plant was

supplied. This shows that the moisture level of the soil of plants can be monitored and controlled periodically. The system was programmed to sense moisture level of plants at a given time. If the moisture content is below the specified threshold moisture value stated in the program code, then desired volume of water is supplied until it reaches threshold moisture value. The system setup was shown in figure 5 below.



Figure5: Hardware layout

## REFERENCES

- [1] Gupta, A., Kumawat, S., & Garg, S. (2016). "Automatic Plant Watering System". *Imperial Journal of Interdisciplinary Research (IJIR)*, 2(4).
- [2] Divani, D., Patil, P., & Punjabi, S. K. (2016). "Automated plant Watering system". *2016 International Conference on Computation of Power, Energy Information and Communication (ICCPEIC)*.
- [3] Tasneem Khan Shifa (2018). "Moisture Sensing Automatic Plant Watering System Using Arduino Uno" *American Journal of Engineering Research (AJER)* 7(7).
- [4] Bishnu Deo Kumar, Prachi Srivastava, Reetika Agrawal, Vanya Tiwari (2017). "Microcontroller Based Automatic Plant Irrigation System" *International Research Journal of Engineering and Technology (IRJET)*.