

A Novel Integrated Converter for Electric Vehicles (EVs)

D. RAMESHRAJ¹, M R. SITHIGANESH², R. SABARISH³, DR. S. BHUVANESWARI⁴, DR. S. KRISHNAVENI⁵, R. RAJA⁶

^{1, 2, 3} Dr. M.G.R. Educational and Research Institute deemed to be University, Chennai

⁴ HOD, Dr. M.G.R. Educational and Research Institute deemed to be University Chennai

^{5, 6} Assistant Professor, Dr. M.G.R. Educational and Research Institute deemed to be University, Chennai

Abstract- A novel integrated converter for electric vehicles (EVs) is proposed in this work. For battery charging operation, the proposed converter system enables a complementary deployment of the utility grid and a solar photovoltaic (PV) system. Since both sources (acting one at a time) utilize the same converter, the developed charging system therefore has a smaller number of components. In addition, an inductor voltage detection (IVD) technique has been incorporated to correct the power factor in continuous conduction mode (CCM), which eliminates the need for a current sensor for power factor correction (PFC). The proposed system operates for all the modes required for an EV e.g., charging, propulsion (PRN) and regenerative braking (RBG). In charging mode (with either grid or solar PV), the proposed system operates as an isolated secondary ended primary inductance converter (SEPIC) converter. In PRN and RBG modes, it operates as a boost converter and a buck converter, respectively. Details of all these modes are described in the paper, along with the design of the components.

Indexed Terms- Power factor correction, electric vehicles, bi-directional DC-DC converter solar PV system, inductor voltage detection.

I. INTRODUCTION

To combat the scarcity of fossil fuel and the environmental issues due to carbon emissions from transportation, research in electric vehicles (EVs) is a priority for researchers worldwide. The major challenges for researchers in EVs are how to reduce the cost, charger size and charging time. The main reasons for the high cost of these vehicles are storage system (battery technology) and the charging infrastructure (charger for the battery). The charging

system of EVs is made using power electronic converters and sensing elements. The power electronic converters are composed of semiconductor devices and passive components, and sensing elements are composed of voltage and current sensors. The cost of these components is usually high. Furthermore, researchers are also concern about making the EVs sustainable; thus, it is desirable to charge the EVs from sustainable power sources. Hence charging of EVs from solar photovoltaic (PV) arrays is a viable option for the future [1].

Solar PV generation is characterized by both diurnal and seasonal variations. This requires grid connection to ensure a reliable power supply for EV chargers. Workplaces office buildings, industries, factories, etc., where solar panel can be installed on rooftops and car parks area are ideal places for solar EV battery charging. There are a few advantages to solar EV charging: a) solar PV charging reduces power demand on the grid because solar power generated locally, b) The EV battery serves as energy storage for PV power and mitigates the problem of large integration of PV into a distribution grid system [2], [3]. A key requirement of an EV battery charger is that all power sources namely; solar PV and grid must be isolated from the battery [4], [5]. To charge the EV from solar PV and grid at least three converters are generally used [6]. First, a DC-DC converter is utilized for maximum power point tracking (MPPT) operation of the solar PV. The output solar PV (after MPPT) is connected to the output of grid interfaced converter (second converter), which forms a DC-link, and then a bidirectional DC-DC converter (third converter) is connected between the DC-link and the battery [7], [8]. The block diagram of such conventional system is shown in Fig. 1.

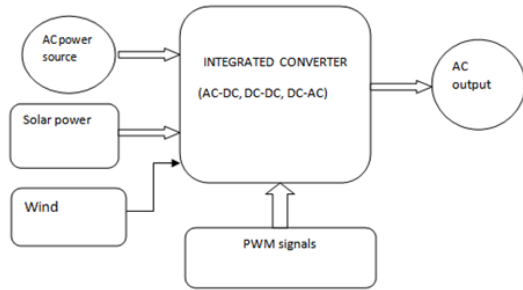

Fig. 1. Block diagram of the conventional solar PV and grid-based battery charging

II. EXISTING SYSTEM

A novel battery charging system that integrates a non-isolated on-board charger (OBC) and low-voltage dc-dc converters (LDCs) by sharing the semiconductor devices and mechanical elements. Thus, the volume of LDCs is reduced radically compared with a conventional non-integrated charging system. The proposed integrated system is configured based on a driving condition that is derived from the analysis of vehicle operating modes. And order to improve system performance, an asynchronous control algorithm is applied to control the on-board charger optimally. In the LDC system, dual LLC resonant converters are composed by sharing a transformer and secondary side components. To improve the efficiency of each LDC, which are operated in the wide input and output voltage range, a duty and frequency control algorithm is proposed

- proposed power conversion system

a new solar powered and grid based single-stage isolated integrated converter for on-board applications, as shown in Fig. 2

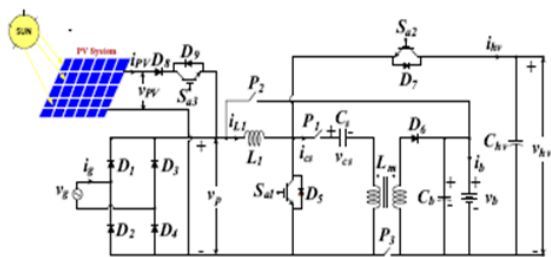

Fig. 3. Configuration of the proposed power conversion system.

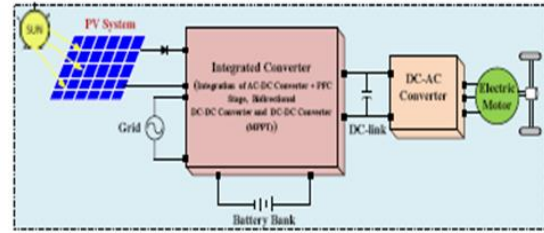

Fig. 4. Block diagram of the proposed system.

features of the proposed system

The important features of the proposed charging system are described as:

- (a) two sources (solar PV and grid) for charging operation, which enhances the reliability of the charger;
- (b) achieves all operational modes of Evs with one converter;
- (c) galvanic isolation between the battery and the power sources for personnel safety and protection of components;
- (d) reduced cost of electricity per unit of charging.

Moreover, the proposed charging system utilizes an inductor voltage detection (IVD) based control technique for PFC operation in the continuous conduction mode (CCM), which eliminates a current sensor requirement and further enhances the compactness of the charging system to make the system more attractive for on-board applications.

III. SIMULATION RESULTS

In this section, the findings of simulation results are discussed. The simulation study was performed on the Simulink platform of Matlab.

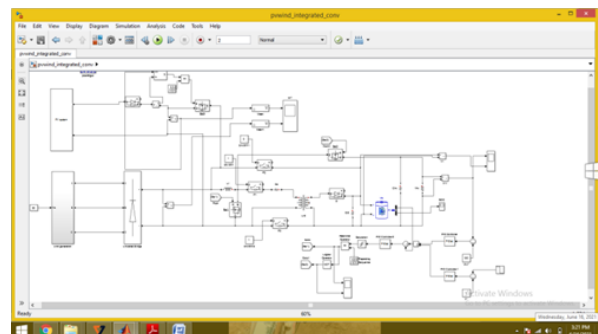

Fig. 5. Simulated Pv and wind

This simulation shows the output a) pv and b) wind in x axis time and y axis pv & wind voltage

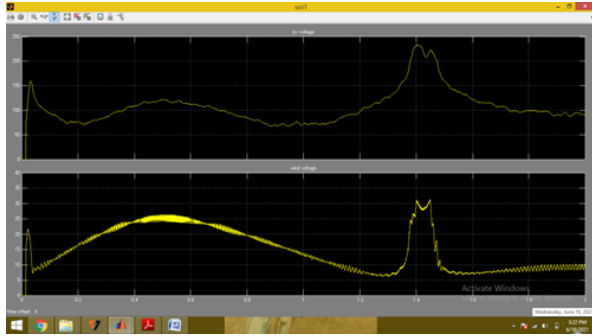
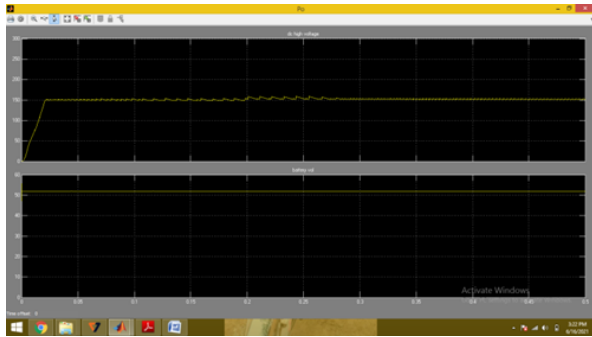
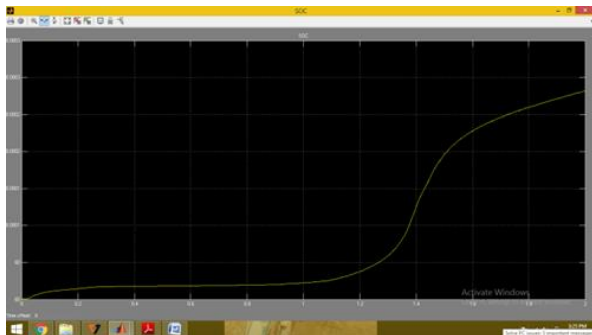

Fig. 6. Pv wind output voltage

This simulation shows the output of Output voltage and battery voltage in y axis with respect x axis time



Output voltage and battery voltage



Battery soc:

IV. ADVANTAGES

- solar PV charging reduces power demand on the grid because solar power generated locally,
- The EV battery serves as energy storage for PV power and mitigates the problem of large integration of PV into a distribution grid system.

CONCLUSION AND FUTURESCOPE

In this paper, a novel on-board power integrated converter that reduces the component count for electric vehicles has been proposed. The proposed system can utilize solar PV and a grid source as an input for battery charging (not simultaneously, but complementary to each other). Both power sources utilize the same part of the converter for charging operation, which leads to the system having a smaller number of components and making the converter more desirable for on-board applications. During day time the solar PV can be a main source for charging, and during night-time the grid power can be utilized for battery charging. Moreover, the proposed system utilizes the inductor voltage detection (IVD) technique for power factor correction (PFC), which eliminates one sensor requirement for PFC. The elimination of the sensor requirement will make the converter more compact. The proposed converter is validated in each mode through computer simulations and the experiments. The results obtained from both the simulations and experiments are in close agreement with each other, which further validates the effective design of the hardware system and the control loop parameters

REFERENCES

- [1] G. R. C. Mouli, P. Bauer, and M. Zeman, "Comparison of system architecture and converter topology for a solar powered electric vehicle charging station," in 2015 9th International Conference on Power Electronics and ECCE Asia (ICPE-ECCE Asia), pp. 1908–1915, Jun. 2015.
- [2] G. R. Chandra Mouli, J. Schijffelen, M. van den Heuvel, M. Kardolus, and P. Bauer, "A 10 kw solar-powered bidirectional EV charger compatible with chademo and combo," IEEE Transactions on Power Electronics, vol. 34, no. 2, pp. 1082–1098, Feb. 2019.
- [3] G. R. Chandra Mouli, P. Bauer, T. Wijekoon, A. Panosyan, and E. Barthlein, "Design of a power-electronic-assisted OLTC for grid voltage regulation," IEEE Transactions on Power Delivery, vol. 30, no. 3, pp. 1086–1095, Jun. 2015.

- [4] CHAdeMO Association, “Technical specifications of quick charger for the electric vehicle,” CHAdeMO Protoc. Rev. 1.1, 2010.
- [5] SAE Electric Vehicle and Plug-in Hybrid Electric Vehicle Conductive Charge Coupler, SAE Std. J1772, 2010.
- [6] A. R. Bhatti, Z. Salam, M. J. B. A. Aziz, K. P. Yee, and R. H. Ashique, “Electric vehicles charging using photovoltaic: Status and technological review,” *Renewable and Sustainable Energy Reviews*, vol. 54, pp. 34–47, 2016.
- [7] G. R. C. Mouli, P. Bauer, and M. Zeman, “Comparison of system architecture and converter topology for a solar powered electric vehicle charging station,” in *2015 9th International Conference on Power Electronics and ECCE Asia (ICPE-ECCE Asia)*, pp. 1908–1915, Jun. 2015.
- [8] A. K. Singh and M. K. Pathak, “A multi-functional single-stage power electronic interface for plug-in electric vehicles application,” *Electric Power Components and Systems*, vol. 46, no. 2, pp. 135–148, 2018.
- [9] S. Biswas, L. Huang, V. Vaidya, K. Ravichandran, N. Mohan, and S. V. Dhople, “Universal current-mode control schemes to charge liion batteries under DC/PV source,” *IEEE Transactions on Circuits and Systems I: Regular Papers*, vol. 63, no. 9, pp. 1531–1542, Sep. 2016.
- [10] J. Traube, F. Lu, D. Maksimovic, J. Mossoba, M. Kromer, P. Faill, S. Katz, B. Borowy, S. Nichols, and L. Casey, “Mitigation of solar irradiance intermittency in photovoltaic power systems with integrated electric-vehicle charging functionality,” *IEEE Transactions on Power Electronics*, vol. 28, no. 6, pp. 3058–3067, Jun. 2013.
- [11] V. D and V. John, “Dynamic modeling and analysis of buck converter based solar PV charge controller for improved MPPT performance,” in *2018 IEEE International Conference on Power Electronics, Drives and Energy Systems (PEDES)*, pp. 1–6, Dec. 2018.
- [12] S. A. Singh, G. Carli, N. A. Azeez, and S. S. Williamson, “Modeling, design, control, and implementation of a modified z-source integrated pv/grid/ev dc charger/inverter,” *IEEE Transactions on Industrial Electronics*, vol. 65, no. 6, pp. 5213–5220, Jun. 2018.
- [13] G. Carli and S. S. Williamson, “Technical considerations on power conversion for electric and plug-in hybrid electric vehicle battery charging in photovoltaic installations,” *IEEE Transactions on Power Electronics*, vol. 28, no. 12, pp. 5784–5792, Dec. 2013.
- [14] J. Traube, F. Lu, D. Maksimovic, J. Mossoba, M. Kromer, P. Faill, S. Katz, B. Borowy, S. Nichols, and L. Casey, “Mitigation of solar irradiance intermittency in photovoltaic power systems with integrated electric-vehicle charging functionality,” *IEEE Transactions on Power Electronics*, vol. 28, no. 6, pp. 3058–3067, Jun. 2013.
- [15] A. Verma, B. Singh, A. Chandra, and K. Al-Haddad, “An implementation of solar PV array based multifunctional EV charger,” in *2018 IEEE Transportation Electrification Conference and Expo (ITEC)*, pp. 531–536, Jun. 2018.
- [16] A. K. Singh, K. A. Chinmaya, and M. Badoni, “Solar pv and grid based isolated converter for plug-in electric vehicles,” *IET Power Electronics*, vol. 12, no. 14, pp. 3707–3715, 2019.
- [17] Y. J. Lee, A. Khaligh, and A. Emadi, “Advanced integrated bidirectional AC/DC and DC/DC converter for plug-in hybrid electric vehicles,” *IEEE Transactions on Vehicular Technology*, vol. 58, no. 8, pp. 3970–3980, Oct. 2009.
- [18] S. Dusmez and A. Khaligh, “A charge-nonlinear-carrier-controlled reduced-part single-stage integrated power electronics interface for automotive applications,” *IEEE Transactions on Vehicular Technology*, vol. 63, no. 3, pp. 1091–1103, Mar. 2014.
- [19] A. K. Singh and M. K. Pathak, “Single-phase bidirectional ac/dc converter for plug-in electric vehicles with reduced conduction losses,” *IET Power Electronics*, vol. 11, no. 1, pp. 140–148, 2018.
- [20] V. Bist and B. Singh, “A unity power factor bridgeless isolated cuk converter-fed brushless dc motor drive,” *IEEE Transactions on Industrial Electronics*, vol. 62, no. 7, pp. 4118–4129, Jul. 2015.
- [21] A. K. Singh and M. K. Pathak, “Integrated converter for plug-in electric vehicles with

- reduced sensor requirement,” IET Electrical Systems in Transportation, vol. 9, no. 2, pp. 75–85, 2019.
- [22] D. Hart, Power Electronics. McGraw-Hill, 2011.
- [23] W. Tang, F. C. Lee, and R. B. Ridley, “Small-signal modeling of average current-mode control,” IEEE Transactions on Power Electronics, vol. 8, no. 2, pp. 112–119, Apr. 1993.
- [24] G. Sen and M. E. Elbuluk, “Voltage and current-programmed modes in control of the z-source converter,” IEEE Transactions on Industry Applications, vol. 46, no. 2, pp. 680–686, Mar. 2010.
- [25] V. S. C. Raviraj and P. C. Sen, “Comparative study of proportionalintegral, sliding mode, and fuzzy logic controllers for power converters,” IEEE Transactions on Industry Applications, vol. 33, no. 2, pp. 518–524, Mar. 1997.
- [26] M. Marvi and A. Fotowat-Ahmady, “A fully ZVS critical conduction mode boost PFC,” IEEE Transactions on Power Electronics, vol. 27, no. 4, pp. 1958–1965, Apr. 2012