

Review on an Intelligent Protection Algorithm for Unsymmetrical Phase Shifting Transformers

KRITIKA SAHU¹, A.V. BAKSHI²

¹Electrical and Electronics Department, P.G. Scholar, CSIT, Durg (C.G.), India.

²Electrical and Electronics Department, Asst. Prof. CSIT, Durg (C.G.), India.

Abstract- This abstract illustrates differential protection philosophy for indirect unsymmetrical phase shifting transformer (IUPST) by using combined wavelet transform principal component analysis (PCA) and support vector machine (SVM). Discrimination between interval fault and magnetizing inrush condition is a very challenging task in IUPST differential protection scheme. Therefore, discrete wavelet transform is used to extract the feature from the relaying signal (i.e. differential current) and the features of the relaying signal is used to train and test the SVM. The IUPST is modelled in PSCAD/EMTDC software to obtain the relaying under different operating conditions. The proposed algorithm is evaluated in MATLAB under forward and backward mode of PST operation and the tested data is simulated in PSCAD/EMTDC by varying inception angle, fault position, tap positions, loading conditions of IUPST. Results shows that the proposed algorithm is stable, reliable and selective under different operating conditions of IUPST.

Indexed Terms- Indirect Unsymmetrical Phase Shifting Transformer (IUPST), Principal Component Analysis (PCA), Support Vector Machine (SVM).

I. INTRODUCTION

PSTs are devices that require continuous monitoring and fast protection because they are essential to the electrical power systems to improve reliability. In PST 70% of faults are caused by short-circuits in its windings. In case of magnetizing inrush and sympathetic inrush large current flows in the source side. This large current from the source results in large differential current, which in turn causes the relay to operate undesirably. Owing to this reason, conventional differential relays are blocked for few

initial cycles of energization which makes the relay operation delayed on switching-in of the PST on faults. Therefore, discrimination between magnetizing inrush and internal fault condition is the key to improve the security of the differential protection scheme. Traditionally, two types of approaches are used for this purpose, that is, harmonic restraint (HR) and waveform identification (WI) concepts. The HR is based on the fact that the second harmonic (sometimes the fifth) component of the magnetizing inrush current is considerably larger than that in a typical fault current. The literature reveals the extensive use of the HR method. However, the HR-based method fails to prevent false tripping of relays because high second harmonic components during internal faults and low second harmonic components are generated during magnetizing inrush for transformers having modern core material. Therefore, the techniques based on detection of second/fifth harmonic component are not useful to discriminate between the magnetizing inrush and internal fault condition of modern power transformers.

The second method consists of distinguishing magnetizing inrush and over-excitation condition from internal fault condition on the basis of WI concept. The development of advanced digital signal-processing techniques and recently introduced support vector machine (SVM) provide an opportunity to improve the conventional WI technique and facilitate faster, secured and dependable protection for phase shifting transformers.

1.1 Power transmission line

The essential part of any electrical distribution system are transmission lines because they allow electricity to be transferred from generation to load. Transmission lines are meant to be closely

interconnected and operate at voltages ranging from 69 to 765 kV.

The simple single line diagram of the model to be studied is shown in Fig.1. Three generators, nine buses, three loads, and six transmission lines are included.

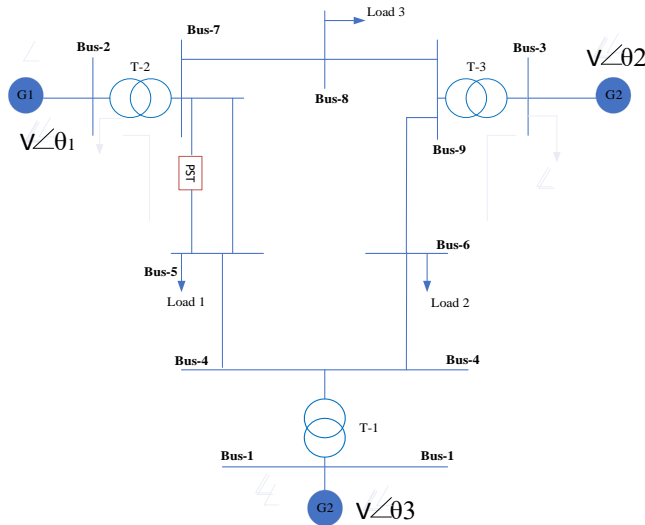

Figure.1. 500kV Single line model to be studied with phase shifting transformer in 9 bus system Operating Conditions of PST

This section will describe briefly the various operating situations of power transmission line safety. This condition of affairs can be classified as follows:

Normal operating condition: In this situation rated or less rated current will flow in PST and differential current in this case is nearly zero for (87P and 87S) and in case of 87T differential current is present and it vary with every tap position.

External fault is the one which occur outside of the protection zone of the relay. It could be LG, LL, LLG, LLL or LLLG fault. In this case huge amount of current above rated current flows in the power system.

Internal fault is the one when transmission line gets braked and falls in ground or whenever arc induces between two phases of the line. The types of internal fault are LG, LL, LLG, LLL, LLLG and TT fault. In

this case huge amount of current above rated current flows in the power system.

Over excitation: whenever large reactive load is removed from system then voltage gets increased this phenomenon is over excitation. In this situation v/f ratio increases from normal one. Due to over excitation differential current occurs due to current imbalance in PST and this differential current has odd harmonics component. 3rd harmonic current is cancelled due to delta connection. So, 5th harmonic component is use for discrimination purpose [4].

Magnetizing Inrush: Whenever large sudden changes in input voltage of PST occur, magnitude of the current in input side increases, due to large magnitude of current core of the PST get saturated this is a magnetizing inrush phenomenon. Input voltage increases during switching-in of PST when energized, and when external fault is recovered and when state of fault is changed like LL to LLG. In this situation differential current occur [4]. Power swings are oscillations in active and reactive power caused by load variation, clearing of faults and generator disconnection [3].

Sympathetic Inrush: When another transformer is connected in parallel with already energized PST then sympathetic inrush will flow in first one (PST). Due to DC decaying component present in inrush of parallel transformer. The DC component flow in PST which is responsible to saturate the core of PST, this phenomenon happens. Sympathetic inrush also depends on switching-in and when external fault is recovered. 2nd harmonic current present in this case is very low. In this case differential current occurs.

1.3 Differential Relay

Differential current relay is mainly two types:

- Simple differential relay
- Percentage differential relay

Percentage differential relay without restraining coil is considered as a simple differential relay.

Number of turns in restraining coil and operating coil decides the slope of the differential relay. Slope of the differential relay is in between differential current vs. restraining current (biased current).

When compare restraining torque with operating torque the final equation will be

$$I_1 - I_2 = T * \frac{I_1 + I_2}{2} + T_0 \tag{1}$$

Where,

$$T = \frac{N_r}{N_o}$$

N_r is the number of turns in restraining coil

N_o is the number of turns in operating coil

I_1 is the current obtained from one of the CT

I_2 is the current obtained from another one of the CT

T_0 is the minimum pick up value of differential relay

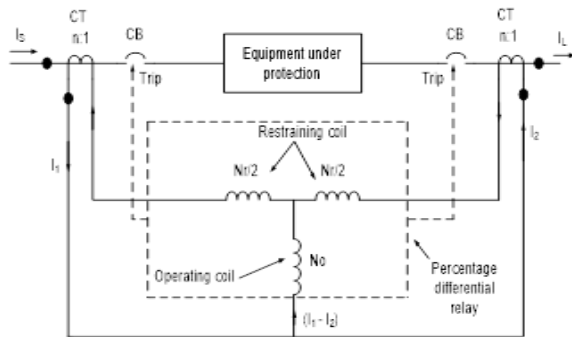

Figure.2. Percentage differential relay

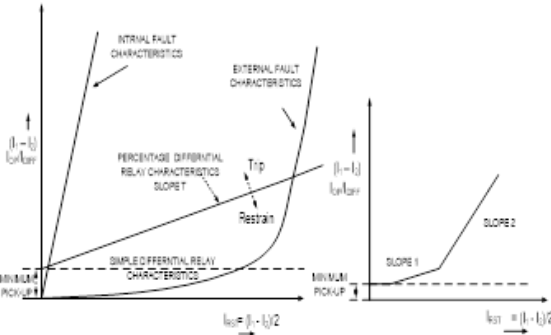

Figure 3.: (A) Percentage differential relay, (B) Dual slope percentage differential relay

From above figure 3.: (B) the percentage differential relay can be made more immune to mal-operation on 'external fault' by increasing the slope of the characteristic. That's why we go for dual slope percentage differential current slope1 gives high sensitivity for internal faults and slope2 gives high security against external fault magnitude of slope2 is greater than slope1 knee point of dual slope

differential current is decided where saturation of CT is started. In the literature mainly differential protection scheme is used for the protection of PST. Mainly two types of protection schemes have been discussed till now in the literatures for PST. Where primary differential relay (87P) is use to protect primary winding of the exciting and series unit and secondary differential relay (87S) is use to protect secondary winding of the exciting and series unit. These 87P and 87S combine protects the PST [5]. Other than these differential relays there exist overall differential relay (87T) to protect primary and secondary winding of the series and exciting unit combined [6].

II. DISCRETE WAVELET TRANSFORM (DWT)

Whenever fault occurs there are always transients present. This transient contains different frequency component of current at different time. The strength of different frequency depends on different operating current. Like in case of inrush 2nd harmonic current are higher than the fundamental current [14].

Different signal processing technique are available to study the different frequency component present in the differential current. One of the techniques is Discrete Fourier Transform DFT. It is used only for stationary signal and it gives only about frequency information and its losses about time information. So, this technique is not suitable for this purpose because differential current contains transients. Another technique is the discrete time Short Time Fourier Transform STFT. It gives information about both frequency as well as time but limited precision. It increases the frequency information by varying window then time information is reducing. So, to overcome the above problem DWT is introduced, it gives information about frequency as well as time at very high precision and it gives information like at what time what frequency component is present which is very useful for analysis of transient in fault current [10].

Discrete signal is comprised by using scaling and wavelet function is:

$$x[n] = \frac{1}{\sqrt{M}} \sum_k U_{\Omega}[l_0, k] \Omega_{l_0, k}[n] + \frac{1}{\sqrt{M}} \sum_{l=l_0}^{\infty} \sum_k U_{\beta}[l, k] \beta_{l, k}[n] \quad (2)$$

Where,

$\Omega_{l_0, k}[n]$ is scaling function

$\beta_{l, k}[n]$ is wavelet function

$U_{\Omega}[l_0, k]$ is approximate coefficient

$U_{\beta}[l, k]$ is detailed coefficient

l_0 is shifting parameter

k is shifting parameter

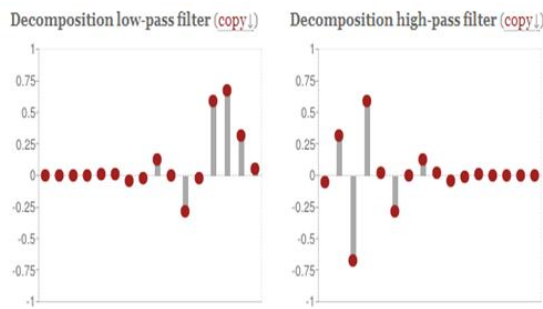

Figure. Error! No text of specified style in document.. Decomposition LPF and HPF

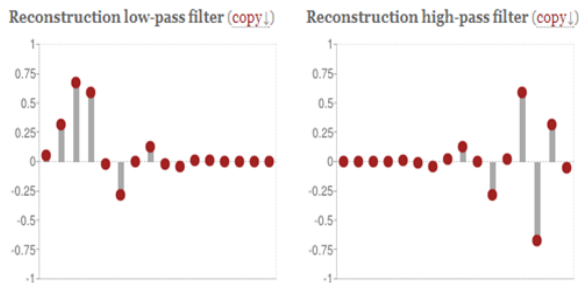

Figure.5. Reconstruction LPF and HPF

$$U_{\Omega}[l_0, k] = \frac{1}{\sqrt{M}} \sum_k x[n] \Omega_{l_0, k}[n] \quad (3)$$

$$U_{\beta}[l, k] = \frac{1}{\sqrt{M}} \sum_k x[n] \beta_{l, k}[n] \quad l \geq l_0 \quad (4)$$

There are many kinds of mother wavelets, like Harr, Daubichies, Coiflet and Symmlet wavelets. Smoothness of db8 (Daubichies) wavelet is same like power signal (differential current). So, it gives vary good result to extract higher harmonics present in differential current. Discrete db8 filter is shown in figure.4.

As from figure.6. differential current is first sampled with sampling frequency f_s ($f_s \geq$

$2f$, f =fundamental frequency) then passes through LPF and HPF parallel. half of lower frequency band is passed through LPF and half of higher frequency band is pass through HPF, the total number of samples after filtering is $is+l - 1$, here L is length of input signal, l is length of FIR of filter, it means number of samples is getting increased after passing again output of LPF through HPF and LPH, so that to make less calculation and memory efficient, number of samples stored by reduce to half of the total sample by taking only even number of samples. This process is called down sampling. Output of LPF is called approximate coefficient and output of HPF is called detailed coefficient. Reconstruction of signal is done by first padding zero in odd places of signal (up sampling) and then pass-through opposite of the filter that is used before for filtering purposes.

Frequency band of detailed and approximate coefficient after m -level of decomposition are:

$$f_{approximate\ c} = \left[0, \frac{f_s}{2^{m+1}} \right]$$

$$f_{detail\ c} = \left[\frac{f_s}{2^{m+1}}, \frac{f_s}{2^m} \right]$$

In this process decompose the signal into 5 level means get detailed coefficient from d1 to d5 and approximate coefficient A5, and waveform of d4 is clearly different for inrush and all types of internal faults so that coefficient of d4 component is use for classification purpose. To obtain waveform of different level of decomposition coefficient reconstruction filter is used which is mentioned in figure.5.

Table for frequency band of various detailed coefficient are:

Table.1. Frequency content in different detailed coefficient

Detailed coefficient	Frequency band (Hz)
d1	[2500, 5000]
d2	[1250, 2500]
d3	[625, 1250]
d4	[312.5, 625]
d5	[156.25, 312.5]

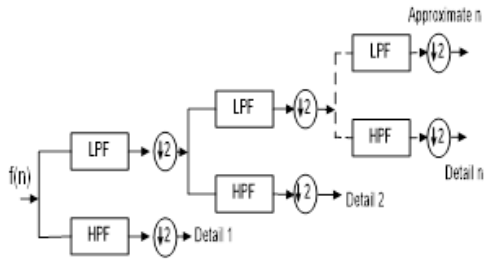

Figure.6. Decomposition filtering block diagram

III. PRINCIPAL COMPONENT ANALYSIS

Here the basic application of principal component analysis is to reduce the dimension of the input vector that goes to the SVM for classification purpose so that the classification accuracy of the SVM increases.

PCA finds a new set of dimensions such that all the dimensions are orthogonal and ranked according to the variance of data among them [7]. It means more important principal axis occurs first.

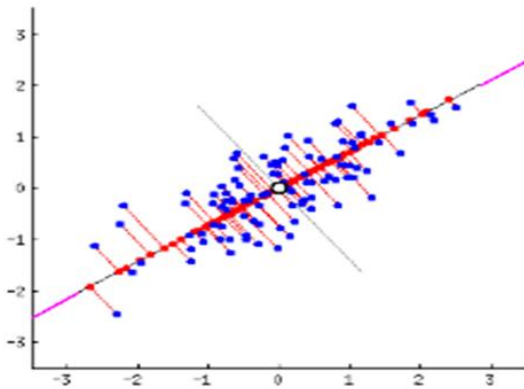

Figure.7. Mapping of data from 2- dimensional to 1-dimensional in the red line axis

PCA works as follows:

- It first calculates the covariance matrix of ‘n’ dimensional input data sets.
- Calculate Eigen vectors and corresponding Eigen values.
- Arrange the Eigen vectors according to their Eigen values in decreasing order.

- Select first ‘m’ Eigen vectors and that will be the new ‘m’ dimensions.
- Transform the original n-dimensional data points into ‘m’ dimensions.

IV. SUPPORT VECTOR MACHINES

Support vector machines are supervised learning model with associated learning algorithm that analyses set of data for classification or regression purposes. Here SVM is used for classification purposes. SVM as a classifier takes training data sets of two categories (class1 and class2) after that it builds the model that assigns new data set into either class1 or class2.

SVMs are based on the idea of finding a hyper-plane that best divides a dataset into two class, in case of two-dimensional data points the hyper-plane would be a line (one dimension less than the dimension of the input data). A good separation is achieved by the hyper-plane that has the largest distance to the nearest training-data point of any class (so-called functional margin), since in general the larger the margin the lower the generalization error of the classifier [15]. Figure .8.shows three hyper-plane H1, H2 and H3, where H1 clearly does not classify the input data sets, but H2 and H3 both are able to classify. Due to the fact that H3 has high functional margin than the H2 hyper-plane, H3 would be the best hyper-plane that would lead to the minimum generalization error.

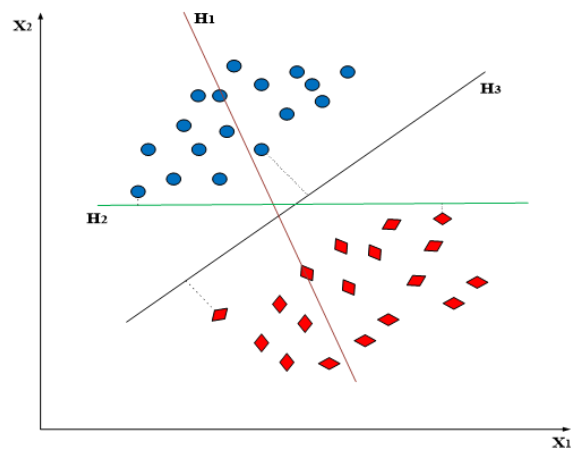

Figure.8. Choosing proper hyper-plane to classify two types of data sets

SVMs are a group of learning machines for solving pattern recognition problems efficiently. SVMs try to find the hyper-plane, which separates optimally the training patterns according to their classes (i.e., hyper-plane with maximum boundary margin). They have a good generalization performance over traditional approaches, since their training is based on the principle of structural risk minimization (SRM) (i.e., minimizing the upper bound on the expected risk), while the training traditional approaches is based on empirical risk minimization (i.e., minimizing the number of the training error). SVMs have a high computational efficiency in terms of speed and complexity [11]. They are also more preferable when dealing with high dimensional data as they are more robust than traditional approaches which may over-fit the data. The description of SVMs classification can be explained as follows:

4.1 Linearly Separable Data

Let us consider a linear classification problem aiming to find optimal separating hyper-plane with maximum margin [15]. Assuming that for the set of n training data:

$$T = \{(\vec{x}_i, y_i); \vec{x}_i \in \mathbb{R}^d, y_i \in \{1, -1\}\} \quad (5)$$

Where,

$i=1, 2, 3, \dots, n$;

\vec{x}_i is a d -dimensional input vector

y_i indicate class 1 or -1 for the corresponding \vec{x}_i

For this \vec{x}_i it is possible to find a maximum margin hyper-plane that linearly separates the appropriate class as shown in the figure 8. In such case hyper-plane can be described by the formula $\vec{w} \cdot \vec{x}_i - b = 0$; where \vec{w} is a weight vector and b is a bias. Additionally, it is possible to find two hyper-planes with no points between them one is $\vec{w} \cdot \vec{x}_i - b = 1$ and another one is $\vec{w} \cdot \vec{x}_i - b = -1$, then a distance between these two hyper-plane is called margin = $\frac{2}{\|\vec{w}\|}$.

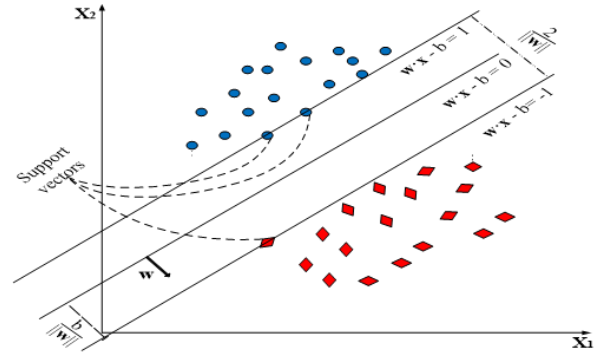

Figure .9. Hard margin classifier

Then class 1 (1) and class 2 (-1) for the input vector is depicted by the following formula.

$$\vec{w} \cdot \vec{x}_i - b > 1, \text{ if } y_i = 1 \quad (6)$$

Or

$$\vec{w} \cdot \vec{x}_i - b < -1, \text{ if } y_i = -1 \quad (7)$$

For better SVM classifier this margin should be maximum, it means the $\|\vec{w}\|$ should be minimum. This finding \vec{w} and b can be done by several optimization techniques [12]. But this optimization problem is solved by introducing Lagrange multipliers and then class of the unknown data x may be determined as follows:

$$Class(\vec{x}) = sign(\vec{w} \cdot \vec{x} - b) \quad (8)$$

Where,

$$\vec{w} = \sum_{i=1}^{N_{sv}} \alpha_i y_i \vec{x}_i \quad (9)$$

Where,

\vec{x} is a input vector to be classify?

\vec{x}_i is a support vector

y_i is a class of given support vector

α_i is a Lagrange multiplier

N_{sv} is a number of support vector

b is a bias value (calculated during training process)

4.2 Linearly Non- separable Data

In case when training data can't be able to get separated by linear hyper-plane then these input vector gets mapped into the one higher dimension feature space in such a way so that the mapped data gets separated by linear hyper-plane [15]. For this purpose, nonlinear function ϕ is used. Then the class of unknown data x may be expressed as follows

Exciting unit faults and Inrush / Series unit fault	Training Sample	Testing Sample	False Detection	Accuracy
Exciting unit faults	696	600	00	100%
Inrush / Series unit fault	3400	2000	00	
Total samples	4096	2600		

$$Class(\vec{x}) = sign(\sum_{i=1}^{N_{sv}} \alpha_i y_i \phi(\vec{x}_i) \cdot \phi(\vec{x}) - b) \quad (10)$$

$$K(\vec{x}_i, \vec{x}) = \phi(\vec{x}_i) \cdot \phi(\vec{x}) \quad (11)$$

Then the decision function of SVM is:

$$Class(\vec{x}) = sign(\sum_{i=1}^{N_{sv}} \alpha_i y_i K(\vec{x}_i, \vec{x}) - b) \quad (12)$$

The most common kernel functions are:

- Linear: $k(\vec{x}_1, \vec{x}) = (\vec{x}_1 \cdot \vec{x})^d$
- Polynomial: $k(\vec{x}_1, \vec{x}) = (\vec{x}_1 \cdot \vec{x} + 1)^d$
- Gaussian radial basis function: $k(\vec{x}_1, \vec{x}) = \exp(-\gamma \|\vec{x}_1 - \vec{x}\|^2)$, for $\gamma > 0$
- Hyperbolic tangent: $k(\vec{x}_1, \vec{x}) = \tanh(k\vec{x}_1 \cdot \vec{x} + c)$, for some (not every) $k > 0$ and $c > 0$

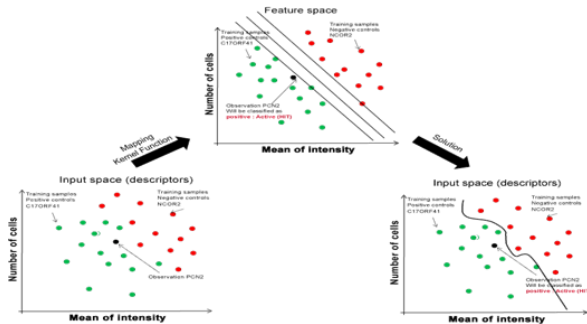

Figure.10. Non-linear based SVM classification

4.3 Soft Margin

It may happen that even in new feature space it is impossible to split this space into two classes. Then, soft margin method may be employed to moderate optimization constraints. Soft margin method allows the classifier to misclassify some examples, what is illustrated in figure. This method introduces two parameters (used in training process) [15].

ξ_i is a slack variable that allow patterns to be in the margin ($0 \leq \xi_i \leq 1$, margin errors) or to be misclassified ($\xi_i > 1$).

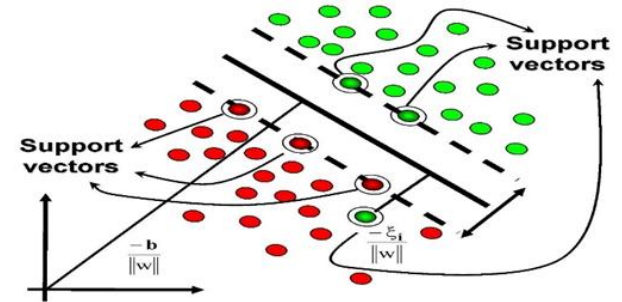

Figure.11. Soft margin classifier

4.4 General Feature

Support vector machine is considered as a promising method for classification due to

- solid mathematical foundations,
- fast optimization algorithms,
- no local optima, unlike in neural networks,
- SVMs maximize the margin, which corresponds to maximizing the generalization performance,
- SVMs deal with nonlinear classification efficiently (employing the kernel trick),
- Good generalization performance even in case of high-dimensional input vector and a small set of training data.

The following algorithm provides the phase shifting transformer protection:

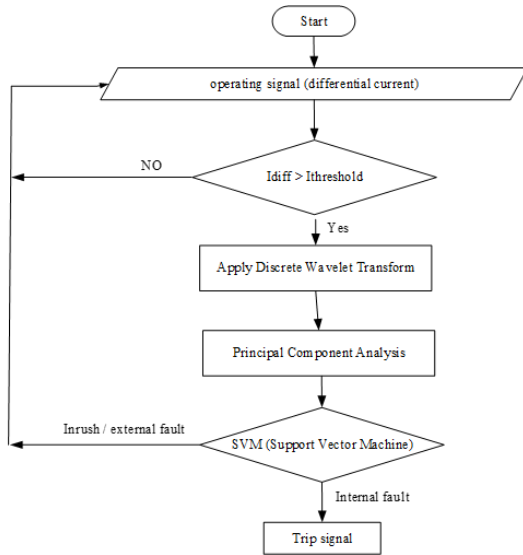

Figure.12. DWT and SVM based phase shifting transformer in 9 bus system

V. CONCLUSION AND SCOPE OF FUTURE WORK

In future implementation of this algorithm will be performed in real time using Machine Learning tools. And also, to enhance the speed of operation and selectivity of the relay, the less data length for the processing and good feature selection would be require for the SVM or other machine learning tools to classify more accurately.

REFERENCES

- [1] T. Schmidt, "Phase-shifting transformers applications and technology," ABB Group, 2016.
- [2] J. McIver, "Phase Shifting Transformers – Principles, Design Aspects and Operation," Siemens Energy, Inc., Weiz, 2015.
- [3] J. H. Harlow, Electric Power Transformer Engineering, CRC Press, 2004.
- [4] M. Tripathy and R. P. Maheshwari, "Power Transformer Differential Protection Based On Optimal Probabilistic Neural Network," *IEEE Transactions on Power Delivery*, Vols. 25, no. 1, pp. 102-112, January 2010.
- [5] M. A. Ibrahim, "Phase Angle Regulating Transformer Protection," *IEEE Transactions on Power Delivery*, Vols. 9, no. 1, pp. 394-404, January 1994.
- [6] Z. Gajic, "Use of Standard 87T Differential Protection for Special Three-Phase Power Transformers—Part I: Theory," *IEEE Transactions on Power Delivery*, vol. 27, no. 3, pp. 1035-1040, 2012.
- [7] P. K. Bera and C. Isik, "Intelligent protection & classification of transients in two-core symmetric phase angle regulating transformers," *CoRR*, June, 2020, arXiv: 2006.09865.
- [8] R. Jimenez and D. A. Tziouvaras, "138 kV phase shifting transformer protection: EMTP modeling and model power system testing," in *Eighth IEE International Conference on Developments in Power System Protection*, 2004.
- [9] J. Verboomen and D. V. Hertem, "Phase shifting transformers: principles and applications," *International Conference on Future Power Systems*, 2005.
- [10] T. Reddy and A. Gulati, "Application of Phase Shifting Transformer in Indian Power System," *International Journal of Computer and Electrical Engineering*, pp. 242-245, 2012.
- [11] P. L. Mao and R. K. Aggarwal, "A Novel Approach to the Classification of the Transient Phenomena in Power Transformers Using Combined Wavelet Transform and Neural Network," *IEEE Transactions on Power Delivery*, Vols. 16, no. 4, pp. 654-660, October 2001.
- [12] J. Faiz and S. Lotfi-Fard, "A Novel Wavelet-Based Algorithm for Discrimination of Internal Faults From Magnetizing Inrush Currents in Power Transformers," *IEEE Transactions on Power Delivery*, Vols. 21, no. 4, pp. 1989-1996, October 2006.
- [13] S. K. Bhasker and M. Tripathy, "Wavelet Transform Based Discrimination Between Inrush and Internal Fault of Indirect Symmetrical Phase Shift Transformer," *IEEE PES General Meeting | Conference & Exposition*, 2014.
- [14] S. K. Bhasker and P. K. Bera, "Differential protection of indirect symmetrical phase shift transformer and internal faults classification using wavelet and ANN," *TENCON IEEE Region 10 Conference*, 2015.

- [15] S. K. Bhasker and P. K. Bera, "Differential protection of indirect symmetrical phase shift transformer using wavelet transform," *IEEE India Conference (INDICON)*, pp. 1-6, 2015.
- [16] S. K. Bhasker and M. Tripathy, "Identification of type of internal fault in indirect symmetrical phase shift transformer based on PRN," *IEEE 7th Power India International Conference (PIICON)*, pp. 1-4, 2016.
- [17] Aktaibi and M. A. Rahman, "An Experimental Implementation of the dq-Axis Wavelet Packet Transform Hybrid Technique for Three-Phase Power Transformer Protection," *IEEE Transactions on Industry Applications*, vol. 50, no. 4, pp. 2919-2927, 2014.
- [18] M. F. Abbas and L. Zhiyuan, "Inrush current discrimination in power transformer differential protection using wavelet packet transform based technique," *IEEE PES Asia-Pacific Power and Energy Engineering Conference*, pp. 944-948, 2016.
- [19] Xiangning Lin, Hanli Weng and Bin Wang, "Identification of Cross-Country Fault of Power Transformer for Fast Unblocking of Differential Protection," *IEEE Transactions on Power Delivery*, Vols. 24, no. 3, pp. 1079 - 1086, July 2009.
- [20] Y. G. Paithankar, *Fundamental of Power System Protection*, India, : PHI Limited, 2003.